

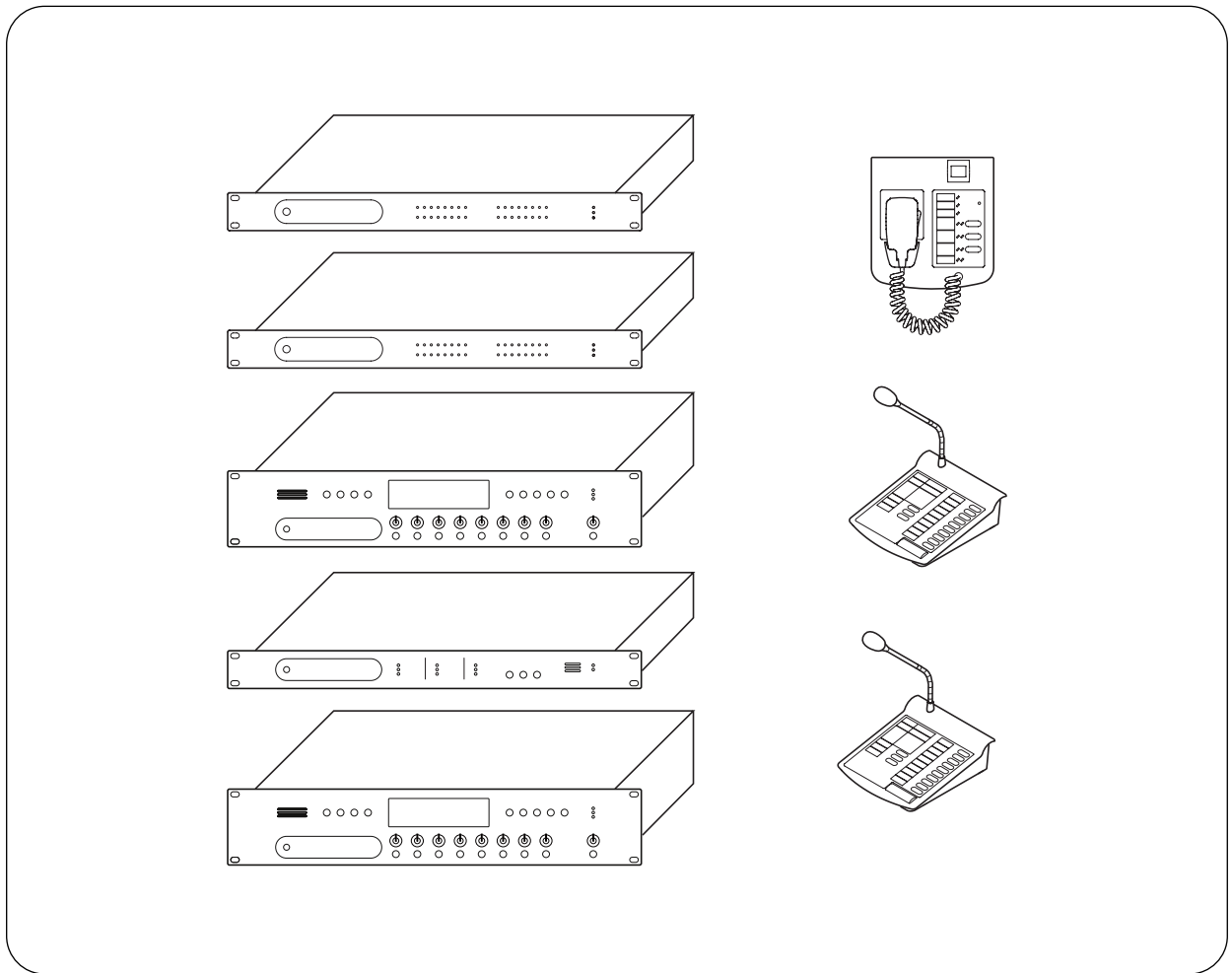

OPERATING INSTRUCTIONS

MATRIX SYSTEM

SX-2000 SERIES



Thank you for purchasing TOA's Matrix System.
Please carefully follow the instructions in this manual to ensure long, trouble-free use of your equipment.

TABLE OF CONTENTS

CHAPTER 1: SX-2000SM SYSTEM MANAGER

1. NOMENCLATURE AND FUNCTIONS	
Front	1-2
2. OPERATING SETTINGS DATA (DIP Switch 2 Operation)	
2.1. Using Settings Data	1-4
2.2. Inserting a CF Card	1-4
3. OUTPUTTING LOG DATA (Operating DIP Switches 1 and 2)	1-5

CHAPTER 2: SX-2000AI AUDIO INPUT UNIT

1. NOMENCLATURE AND FUNCTIONS	
Front	2-2
Fluorescent Display	2-4
2. KEY LOCK SETTINGS AND CANCELLATION (DIP Switch 1 Operation)	2-6
3. OPERATING THE MENU SCREEN	
3.1. Menu Screen Operation Keys	2-7
3.2. Menu Screen Hierarchical Chart	2-8
3.3. Explanations of Menu Screen Items	2-9

CHAPTER 3: SX-2100AI AUDIO INPUT UNIT

1. NOMENCLATURE AND FUNCTIONS	
Front	3-2
Fluorescent Display	3-4
2. KEY LOCK SETTINGS AND CANCELLATION (DIP Switch 1 Operation)	3-6
3. OPERATING THE MENU SCREEN	
3.1. Menu Screen Operation Keys	3-7
3.2. Menu Screen Hierarchical Chart	3-8
3.3. Explanations of Menu Screen Items	3-9

CHAPTER 4: SX-2000AO AUDIO OUTPUT UNIT

1. NOMENCLATURE AND FUNCTIONS	
Front	4-2
Fluorescent Display	4-4
2. KEY LOCK SETTINGS AND CANCELLATION (DIP Switch 1 Operation)	4-6
3. OPERATING THE MENU SCREEN	
3.1. Menu Screen Operation Keys	4-7
3.2. Menu Screen Hierarchical Chart	4-8
3.3. Explanations of Menu Screen Items	4-9

CHAPTER 5: SX-2100AO AUDIO OUTPUT UNIT

1. NOMENCLATURE AND FUNCTIONS

Front	5-2
Fluorescent Display	5-4

2. KEY LOCK SETTINGS AND CANCELLATION (DIP Switch 1 Operation)

5-6

3. OPERATING THE MENU SCREEN

3.1. Menu Screen Operation Keys	5-7
3.2. Menu Screen Hierarchical Chart	5-8
3.3. Explanations of Menu Screen Items	5-9

CHAPTER 6: SX-2000CI CONTROL INPUT UNIT

1. NOMENCLATURE AND FUNCTIONS	6-2
-------------------------------------	-----

CHAPTER 7: SX-2000CO CONTROL OUTPUT UNIT

1. NOMENCLATURE AND FUNCTIONS	7-2
-------------------------------------	-----

CHAPTER 8: RM-200SF FIREMAN'S MICROPHONE

1. NOMENCLATURE AND FUNCTIONS	8-2
-------------------------------------	-----

2. INDICATOR STATUS

2.1. Indicators During Zone Selection	8-4
2.2. Talk Key Indicators	8-5
2.3. Indicators When Changing BGM Patterns	8-6
2.4. Indicators During General-Purpose Pattern Broadcast	8-6
2.5. Indicators During Lamp Test	8-7
2.6. Indicators on Failure Output Receipt	8-8
2.7. Indicators at the Time of Failure Output Reset	8-9
2.8. Indicator State at the Time of Emergency Broadcast Pattern Start	8-10
2.9. Indicator State at the Time of Emergency Broadcast Pattern Stop	8-11
2.10. Indicator State at the Time of Emergency Sequence Stop	8-11
2.11. Indicator State at the Time of Emergency Sequence Phase Shift	8-12
2.12. Indicator State at the Time of Emergency Reset	8-13

CHAPTER 9: RM-200SA REMOTE MICROPHONE RM-210 REMOTE MICROPHONE EXTENSION

1. NOMENCLATURE AND FUNCTIONS

1.1. RM-200SA	9-2
1.2. RM-210	9-4

2. INDICATOR STATUS

2.1. Indicators During Zone Selection	9-5
2.2. Talk Key Indicators	9-6
2.3. Indicators When Changing BGM Patterns	9-6
2.4. Indicators During General-Purpose Pattern Broadcast	9-7

2.5. Indicators During General EV Broadcasts	9-7
2.6. Indicators Showing RM Broadcast Status	9-8
2.7. Indicators During Lamp Test	9-8
2.8. Indicators on Failure Output Receipt	9-9
2.9. Indicators at the Time of Failure Output Reset	9-10
2.10. Indicator State at the Time of Emergency Broadcast Pattern Start	9-11
2.11. Indicator State at the Time of Emergency Broadcast Pattern Stop	9-12
2.12. Indicator State at the Time of Emergency Sequence Stop	9-12
2.13. Indicator State at the Time of Emergency Sequence Phase Shift	9-13
2.14. Indicator State at the Time of Emergency Reset	9-14

CHAPTER 10: OPERATION

1. BGM AND GENERAL BROADCASTING

1.1. Broadcasting from the SX-2000AI, SX-2100AI, SX-2000AO, or SX-2100AO	
1.1.1. Broadcasting using th function key	10-2
1.1.2. Broadcasting using the channel key	10-3
1.2. Broadcasting from the RM-200SF, RM-200SA, and RM-210	10-4
1.2.1. Example of broadcasting to the selected (pattern-designated) zone ..	10-5
1.2.2. Example of broadcasting to the selected (individual) zone	10-6
1.2.3. Example of BGM broadcasting	10-7
1.2.4. Example of general broadcasting	10-7
1.2.5. Example of general EV broadcasting	10-8

2. MAKING GENERAL URGENCY ALL-CALLS

2.1. Making General Urgency All-Calls from the RM-200SA	10-9
2.2. Making General Urgency All-Calls from the RM-200SF	10-10

3. EMERGENCY BROADCASTS

3.1. Typical System Examples	10-11
3.2. Remote Microphone Operation Example	10-13

4. MAKING LOCAL BROADCASTS (SX-2100AO only)

5. ADJUSTING INPUT/OUTPUT VOLUME

6. MONITORING INPUT/OUTPUT CHANNELS

7. DETECTING FAULT

7.1. Fault Detection Setting Example	10-19
7.2. Case Example of Malfunction	10-20
7.3. Remote Microphone's Operation Example	10-21
7.4. SX-2000SM's Operation Example	10-22
7.5. Example of Executing the Failure Reception and Failure Reset by Way of the Control Input Terminals	10-24

8. LAMP TEST

8.1. Remote Microphone's Operation Example	10-25
8.2. SX-2000SM's Operation Example	10-26

Chapter 1

SX-2000SM SYSTEM MANAGER

The SX-2000SM System Manager is capable of performing audio signal routing and priority control for the entire SX-2000 system. It comes with 8 control inputs, 8 control outputs, failure status output, failure status input, and other functions that include keys, access indicators, mode indicators and failure indicators, enabling a wide range of control and status monitoring.

Each function can be set using the SX-2000 Setting Software, and the settings data saved to a Compact Flash (CF) card. By inserting the programmed CF card into the SX-2000SM, each control can be performed for the entire system. It is also possible to record the entire system's operation log and store its contents on the CF card as an operation log.

The SX-2000SM is a 1U-size* unit that can be mounted in an EIA equipment rack. It has two power supply inputs, one of which can be connected to a backup power source to protect against power failures.

*1U size = 44.5 mm (standard size)

1. NOMENCLATURE AND FUNCTIONS

[Front]

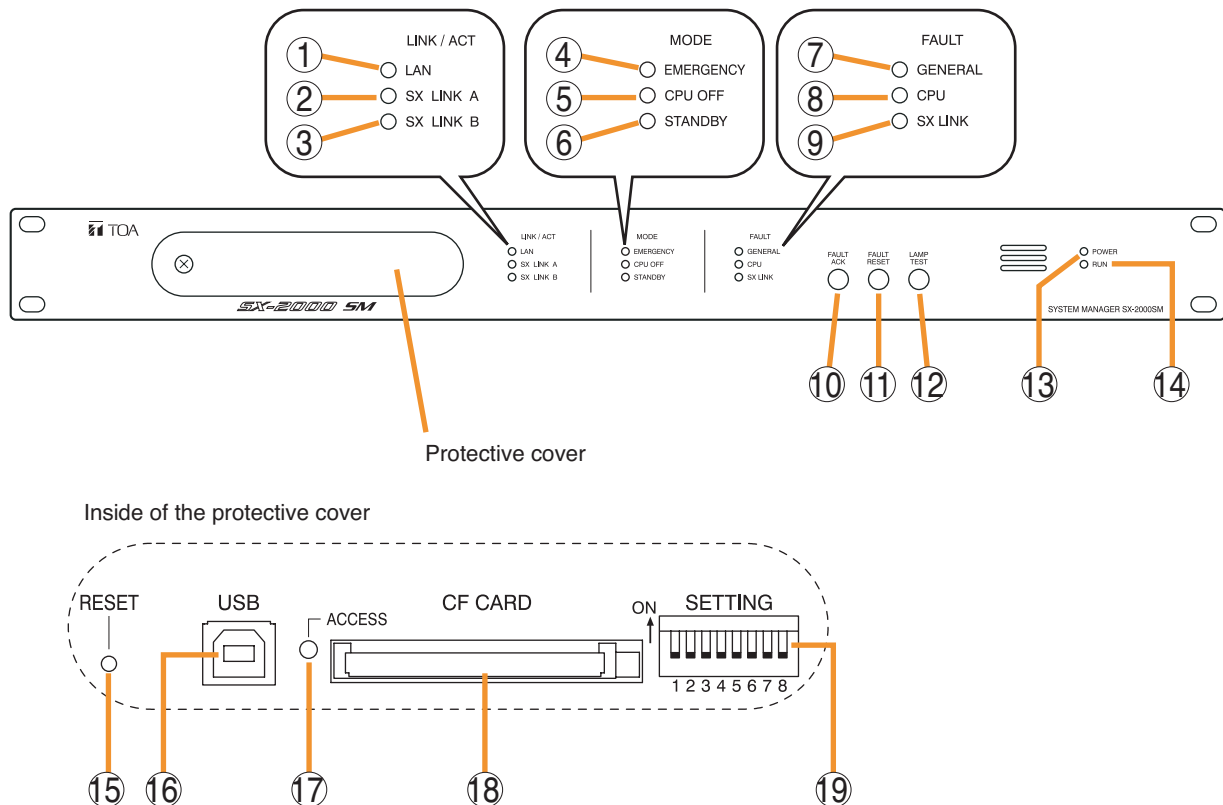

1. LAN Indicator [LAN] (Green)

Lights when the LAN connection terminal on the rear panel is connected, and flashes during LAN communications.

2. SX Link A Indicator [SX LINK A] (Green)

Lights when the SX Link A connection terminal on the rear panel is connected, and flashes while communications are being performed via the SX Link A terminal.

3. SX Link B Indicator [SX LINK B] (Green)

Lights when the SX Link B connection terminal on the rear panel is connected, and flashes while communications are being performed via the SX Link B terminal.

4. Emergency Indicator [EMERGENCY] (Red)

Lights while the general urgency all-call is being made (p. 10-9) or when the SX-2000 system is in an emergency condition, and flashes when a 24 V emergency cutoff* state occurs involving any SX-2000AO within the system.

* In the SX-2000 system, a 24 V emergency cutoff input terminal that allows control of an emergency audio input is provided on the SX-2000AO's rear panel. When the SX-2000 system is combined with another emergency broadcast system, a 24 V DC is normally kept being

supplied to this emergency cutoff input terminal and is cut off (24 V emergency cutoff function) in emergency situations. This interrupts the general-purpose broadcast from the SX-2000, allowing the emergency broadcast system to override it. (For details, see the separate Installation Manual, "Installation.")

5. CPU OFF Indicator [CPU OFF] (Red)

Lights while the general urgency all-call (CPU OFF state) is being made (p. 10-9).

6. Standby Indicator [STANDBY] (Yellow)

Lights when the SX-2000 system is operating on the backup power supply during power failures. It also lights when the system reset cannot be performed using the SX-2000 Setting software. Note that if the standby indicator lights, it is not possible to restart your SX-2000SM using the Setting software.

To perform system reset, press the Reset key (15) inside the protective cover to restart.

7. General Indicator [GENERAL] (Yellow)

Lights while the general urgency all-call is being made (p. 10-9) or when a failure is detected in the SX-2000SM. Lights or flashes when a failure is detected in the system.

8. CPU Indicator [CPU] (Yellow)

Lights while the general urgency all-call is being made (p. 10-9) or when a failure is detected in the SX-2000SM.

9. SX Link Indicator [SX LINK] (Yellow)

Flashes when a cable is connected to neither the rear panel-mounted SX Link terminal A nor B.

10. Fault Ack Key [FAULT ACK]

The buzzer will sound when a failure is detected in the SX-2000 system. Press this key to stop the buzzer.

11. Fault Reset Key [FAULT RESET]

Pressing this key resets the failure information (the buzzer and fault indicators) for the entire SX-2000 system.

Set the mode for operation method using DIP switch 4 (19).

12. Lamp Test Key [LAMP TEST]

Used to test each indicator on the front panel of the SX-2000SM.

All Mode and Fault indicators (4) – (9) remain lit and the buzzer sounds as long as this key is pressed.

13. Power Indicator [POWER] (Blue)

Lights when the power is switched on.

14. RUN Indicator [RUN] (Green)

Normally flashes continuously.

Goes off while the general urgency all-call is being made (p. 10-9).

15. Reset Key [RESET]

Pressing this key reactivates the SX-2000SM. The entire system, including the SX-2000AI, SX-2100AI, SX-2000AO, and SX-2100AO is reactivated.

Notes

- Reactivating the system stops broadcasts currently in progress.
- Do not keep pressing the key for over 1 second. The unit cannot operate.
If the unit operation is suspended, press the Reset key for less than one second again.

16. USB Port [USB]

This port is not used.

17. CF Card Access Indicator [ACCESS] (Green)

Flashes while reading from or writing to a CF card.

Note

Do not remove and reinsert the CF card nor operate the DIP switch (19) while this indicator is flashing.

18. CF Card Slot [CF CARD]

Use this slot to insert the CF card to operate settings data or write log data to the card.

- For settings data operation, see p. 1-4.
- For the method of writing log data, see p. 1-5.

Note

Removing and reinserting the CF card requires DIP switch settings. If the CF card is removed and reinserted without performing correct DIP switch settings, this may cause settings data loss or damage the card.

19. DIP Switch [SETTING]**• Switch 1**

Used to read log data (p. 1-5).

ON: Allows log data to be written into the CF card.

OFF: Normally select this position.

• Switch 2

Used to perform CF card access settings (p. 1-4).

ON: Stops access to the CF card.

OFF: Normally select this position.

• Switch 3

Set whether or not to enable online control using the SX-2000 Setting Software.

(For details, see the separate Installation Manual, "Installation.")

ON: Disables online writing of settings data and system reset.

OFF: Normally select this position.

• Switch 4

Set the method of operation to reset the failure information (the buzzer and fault indicators) with the FAULT RESET key (11).

(For details, see the separate Installation Manual, "Installation.")

In the same manner as the FAULT RESET key operation, the failure information can also be reset by shorting the RES terminals of the Data input terminals (26) at the timing set here.

ON: Sets to the accidental operation prevention mode.

OFF: Sets to the one touch mode.

(For the operation methods in each individual mode, see the separate Installation Manual, "Installation.")

• Switches 5 – 8

These switches are not used.

Note

Switches 1 – 8 are set to the OFF position by default.

2. OPERATING SETTINGS DATA (DIP Switch 2 Operation)

2.1. Using Settings Data

The SX-2000 system is operated by storing the data set using the SX-2000 Setting Software on a CF card and inserting the card into the SX-2000SM.

Note: Be sure to insert the CF card containing the settings data into the CF card slot.

2.2. Inserting a CF Card

The DIP switch must be set when inserting the CF card into the SX-2000SM. Follow the procedure below:

Note: Do not operate the DIP switch while the CF card access indicator inside the protective cover is flashing.

Step 1. Remove the protective cover on the SX-2000SM's front panel by unscrewing it with a Phillips screwdriver.

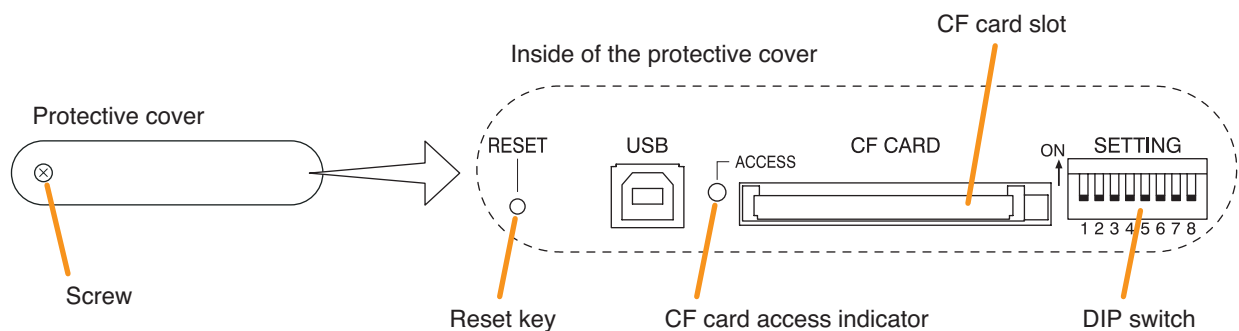

Step 2. Confirm that the CF card access indicator is unlit.

Step 3. Set DIP switch 2 to ON.

Note

DIP switch 2 is set to the OFF position by default.

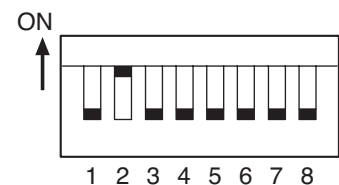

Step 4. Insert the CF card containing the settings data into the CF card slot.

Then, the buzzer sounds.

Setting DIP switch 2 to OFF in Step 5 stops the buzzer.

Step 5. Set DIP switch 2 to OFF.

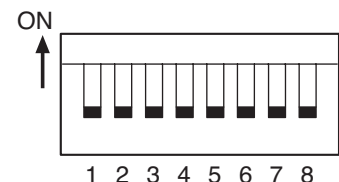

Step 6. Press the Reset key.

The SX-2000 system is reactivated.

Note

Reactivating the system stops broadcasts currently in progress.

Step 7. Replace the protective cover.

3. OUTPUTTING LOG DATA (Operating DIP Switches 1 and 2)

By writing the SX-2000 system's log data to a CF card in the ".s2l" file format and displaying this data on a PC installed with the SX-2000 Setting Software, the data can be output as an Excel CSV file. The log data includes 2 types of data: Operation log data that contains all logs and Failure log data that contains only failure logs. Both data are saved to a CF card with a file name "Sx2kOp**.s2l" for the Operation log data and "Sx2kFa**.s2l" for the Failure log data. ("**" represents a number from 00 to 99 indicating the order in which the logs have been saved. If more than 100 files are saved, the oldest files are overwritten in chronological order.)

The newness or oldness of a file may be ascertained by checking its date. Shown below is the procedure for writing the SX-2000SM's log data to the CF card.

Notes

- When storing log data on a CF card, confirm in advance that it has at least 15 megabytes of free space.
- Do not operate the DIP switch while the CF card access indicator inside the protective cover is flashing.
- Reactivating the SX-2000SM erases the log data temporarily stored in SX-2000SM memory. So, when storing log data on a CF card, be sure to perform that before reactivating the SX-2000SM.
- The SX-2000SM operates on the current setting data until restarted even if the CF card has been removed from the SX-2000SM for reading log data.

Step 1. Remove the protective cover on the SX-2000SM's front panel by unscrewing it with a Phillips screwdriver.

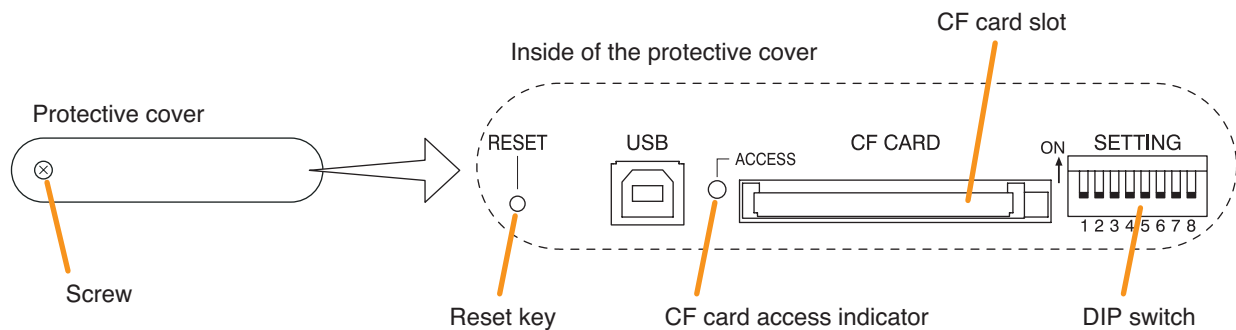

Step 2. Set DIP switch 1 to ON.
Log data is saved to the CF card at this time.

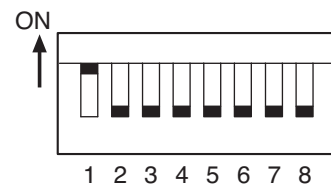

Note: DIP switch 1 is set to OFF by default.

Step 3. Confirm that the CF card access indicator has gone off, then set DIP switch 1 to the OFF position.

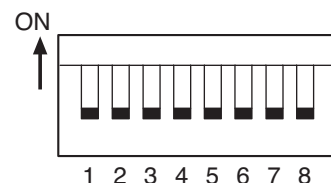

Step 4. Set DIP switch 2 to ON.
Access to the CF card stops, allowing the card to be removed.

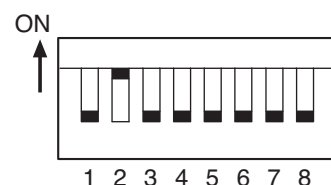

Step 5. Remove the CF card from the card slot.

Step 6. Insert the CF card into the PC's card slot and start the SX-2000 Setting Software.
Confirm the log data using the SX-2000 Setting Software.
For details, see the separate Setting Software Instructions, "Utility."

Step 7. Insert the CF card with the saved settings data into the SX-2000SM's CF card slot.
Inserting the CF card causes the buzzer to sound.
Setting DIP switch 2 to OFF in Step 8 stops the buzzer.

Step 8. Set DIP switch 2 to OFF.
The CF card can be inserted.

Note

When changing the setting data, be sure to press the Reset key to restart the SX-2000 system after turning off DIP switch 2.
Reactivating the system stops broadcasts currently in progress.

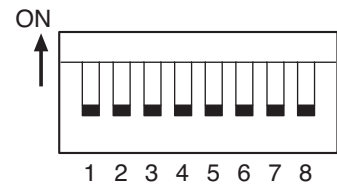

Step 9. Replace the protective cover.

Chapter 2

SX-2000AI AUDIO INPUT UNIT

The SX-2000AI is an audio input unit for use with the SX-2000 system. It features modular construction that allows it to handle from 2 to 8 inputs per unit. It can be mounted in an EIA equipment rack (2U size*), and multiple units can be installed in different locations with no need to centralize in one location.

The SX-2000AI transmits audio signals to the SX-2000AO or SX-2100AO Audio Output Units by means of digital transmission in normal operating condition. However, if no general broadcasts can be made due to system failures, the SX-2000AI uses an analog transmission path to transmit audio signals, enabling all-zone calls to be made (referred to as "general urgency all-call" in this manual).

The SX-2000AI is equipped with 2 power inputs, allowing the connection of a backup power supply for use during power failures. Level meters provided for each input channel allow monitoring of audio input levels. Input volumes can be adjusted using the input volume controls on the front panel, however the maximum volume when the volume control knob is rotated fully clockwise is a default value defined by the SX-2000 Setting Software.

Also, any input channel can be monitored using the internal speaker. The key lock function, designed to prevent accidental mistaken operation, can disable input volume control and channel key settings.

* 1U size = 44.5 mm (standard size)

1. NOMENCLATURE AND FUNCTIONS

[Front]

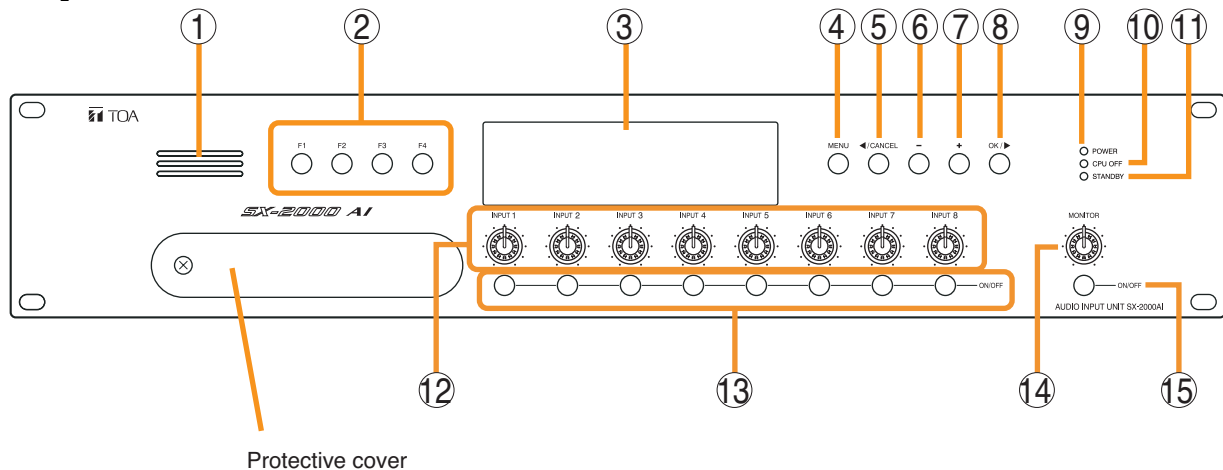

Inside of the protective cover

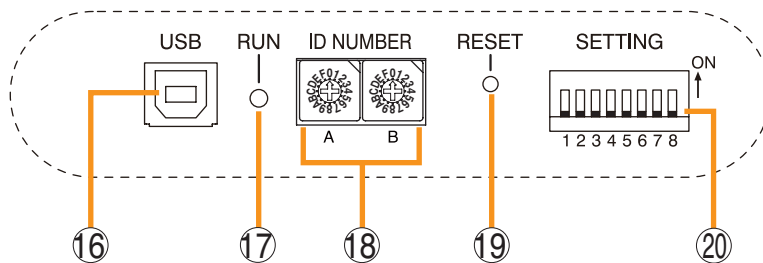

1. Monitor Speaker

Allows any input channel to be monitored.

2. Function Keys [F1, F2, F3, F4]

Pressing a function key executes the function that has been assigned to that key using the SX-2000 Setting Software. (See the separate Setting Software Instructions, "Event Settings.")

3. Fluorescent Display

The default display shows device numbers and firmware versions.



Displays the SX-2000AI's current operation status, input level, etc. (See [p. 2-4](#).)

4. Menu Key [MENU]

Pressing this key displays the fluorescent display's menu screen. Whenever this key is pressed, the screen returns to the default display for whatever portion of the menu screen is displayed.

5. Cancel Key [◀/CANCEL]

Used to switch the menu screen.

6. Minus Key [-]

Used to switch the menu screen. When the Monitor ON/OFF Key (15) is set to ON, use this key to select which channel to monitor. The selected channel number decreases by one each time this key is pressed.

7. Plus Key [+]

Used to switch the menu screen. When the Monitor ON/OFF Key (15) is set to ON, use this key to select which channel to monitor. The selected channel number increases by one each time this key is pressed.

8. OK Key [OK/▶]

Used to switch the menu screen.

9. Power Indicator [POWER] (Blue)

Lights when the power is switched on.

10. CPU OFF Indicator [CPU OFF] (Red)

Lights while the general urgency all-call (CPU OFF state) is being made ([p. 10-9](#)).

11. Standby Indicator [STANDBY] (Green)

Lights while the unit is being initialized at power-on or at reset.

Flashes when the fluorescent display is in light shutoff mode and the light stays unlit.

Lights when the SX-2000 system is operating on the backup power supply during power failures.

12. Input Volume Controls [INPUT 1 – 8]

Adjust the input volume of each input channel. Rotating the control fully counterclockwise mutes the input sound source connected to that channel and causes the input ON/OFF indicator (28) on the fluorescent display to turn off.

When an input channel's "Type" is set to "Emergency" on the SX-2000 Setting software, the input signal source is made to bypass this Input volume control. (See the separate Setting Software Instructions, "System Settings.")

13. Channel Keys [ON/OFF]

Turn each input channel on or off. The input channel alternates between on and off each time this key is pressed.

Other functions can also be assigned to each key by using the SX-2000 Setting Software. (See the separate Setting Software Instructions, "Event Settings.")

When an input channel's "Type" is set to "Emergency" on the SX-2000 Setting software, the input signal source is made to bypass this Channel key. (See the separate Setting Software Instructions, "System Settings.")

14. Monitor Volume Control [MONITOR]

Adjusts the sound volume of the monitor speaker (1).

15. Monitor ON/OFF Key [ON/OFF]

Enables or disables the audio monitor function for the selected input channel. The monitor function alternates between on and off each time this key is pressed.

16. USB Port [USB]

This port is not used.

17. RUN Indicator [RUN] (Green)

Normally flashes continuously.

18. ID Switch [ID NUMBER]

Sets the SX-2000AI's device number. (See the separate Installation Manual, "Installation.")

19. Reset Key [RESET]

Pressing this key resets the SX-2000AI.

Notes

- Resetting the SX-2000AI stops broadcasts in a part of or all zones currently in progress via the reset SX-2000AI.
- Do not keep pressing the key for over 1 second. The unit cannot operate. If the unit operation is suspended, press the Reset key for less than one second again.

20. DIP Switch [SETTING]

Performs key lock function settings. (See [p. 2-6](#).)

• Switch 1

ON: Disables operation of the front panel input volume controls and channel keys.

OFF: Cancels key lock status.

• Switches 2 – 8

These switches are not used.

Note

Switches 1 – 8 are set to the OFF position by default.

[Fluorescent Display]

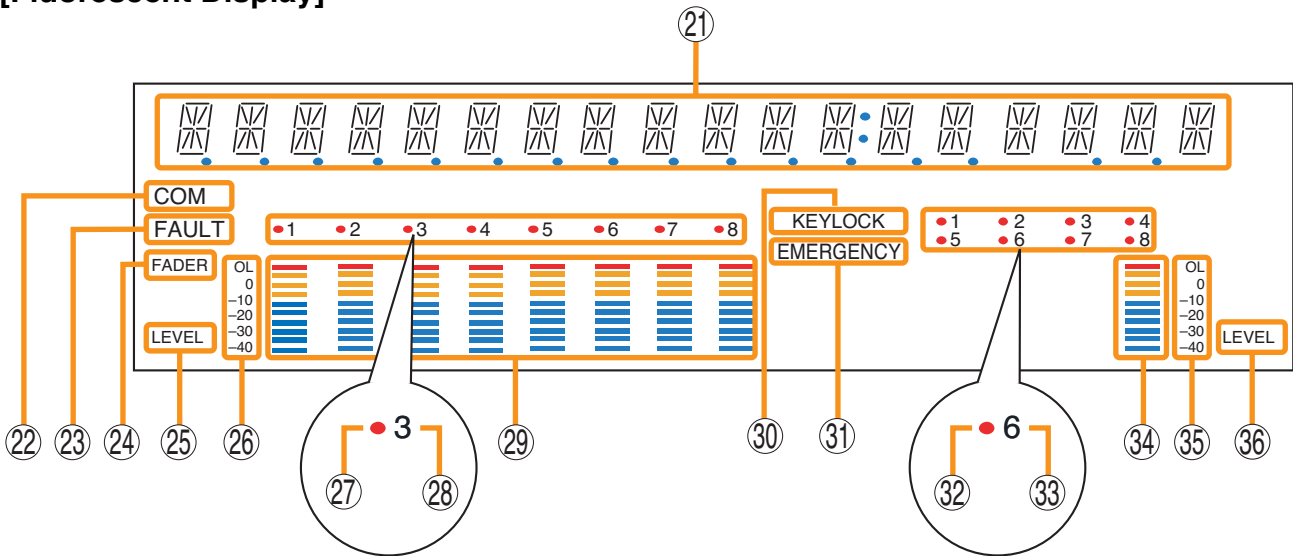

Notes

- A timer-activated light shutoff function can be set for the fluorescent display using the SX-2000 Setting Software. (See the separate Setting Software Instructions, "Basic Settings.") When the light shutoff function has been set, if the SX-2000AI is not operated for 5 minutes or more, the fluorescent display's light goes off and the standby indicator (11) begins to flash. Pressing any keys other than the function keys on the front panel resets the screen display.
- Normally, the fluorescent display's light goes off at the time of the power failure.
- While the SX-2000 system is in an emergency condition, the fluorescent display's light does not go off even if the power fails.

21. Text Display Area

Displays the menu screen information when the corresponding function key is pressed.

22. COM Indicator [COM]

Flashes to indicate a communications error.

23. Fault Indicator [FAULT]

Flashes when a system failure, incorrect system configuration* or communications error is detected. This indicator continues to flash until failure conditions return to normal.

* When the system or module configuration differs from the contents set by the SX-2000 Setting Software.

24. Input Level Meter Fader Indicator [FADER]

Lights when the input level meter indicates the sound volume set using the SX-2000 Setting Software or input volume control.

25. Input Level Meter Level Indicator [LEVEL]

Lights when the input level meter indicates the level being input to the SX-2000AI.

26. Input Level Meter Scale

27. Input Indicator

The input channel to be monitored lights red.

28. Input ON/OFF Indicator

Indicates the unit's operating status when the corresponding channel key is pressed.

The indicator state differs depending on the function assigned to each channel key as follows.

Function assigned to the channel key	When ON	When OFF
Input ON/OFF	Lights*	Unlit
General-purpose pattern broadcast's activation and termination	Flashes	Lights

* The indicator state is "Unlit" when the input volume is muted.

29. Input Level Meter

Indicates the actual level or a set volume value on each input channel.

30. Key Lock Indicator [KEY LOCK]

Lights when the input volume controls and channel keys are all locked. (See p. 2-6, "Key Lock Settings and Cancellation.")

31. Emergency Indicator [EMERGENCY]

Lights when the SX-2000 system is in an emergency condition.

32. Remote Microphone Output Status Indicator

Lights red continuously as long as announcements are made from the RM-200SF, RM-200SA, or RM-210 Remote Microphone.

33. Remote Microphone Connection Status Indicator

The device number of the Remote Microphone connected to the SX-2000AI lights.

34. Monitor Level Meter

Indicates the sound volume level of the input channel being monitored.

35. Monitor Level Meter Scale

Lights when the Monitor ON/OFF Key (15) is set to ON.

36. Monitor ON/OFF indicator [LEVEL]

Lights when the Monitor ON/OFF Key (15) is set to ON.

2. KEY LOCK SETTINGS AND CANCELLATION (DIP Switch 1 Operation)

It is possible to disable the input volume controls, and channel keys in order to prevent mistaken operation. The input volume level set while the key lock function is used takes effect after the key lock has been released.

Note

When the SX-2000 system is placed in an emergency condition during key lock OFF, the emergency sound level preset with the front-mounted volume control knob is invalid, but that defined by the SX-2000 Setting Software is valid.

During key lock ON, however, the volume level set with the input volume control knob is valid even if the SX-2000 system is placed in an emergency condition. Before setting key lock function to ON, be sure to adjust the input volume control knob corresponding to the emergency source channel for a proper sound level.

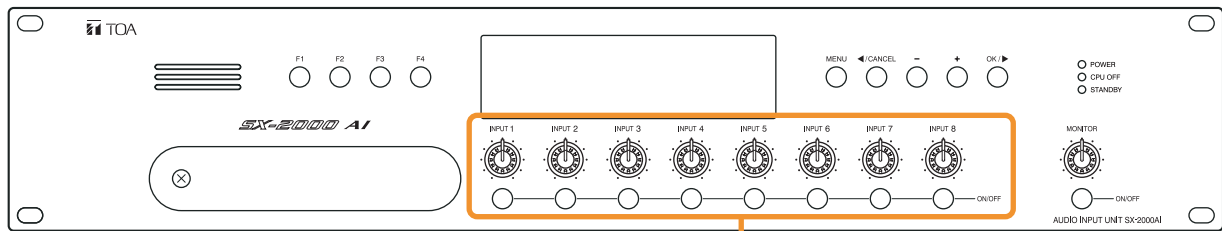

Controls and Keys that can be locked

Step 1. Remove the protective cover on the SX-2000AI's front panel by unscrewing it with a Phillips screwdriver.

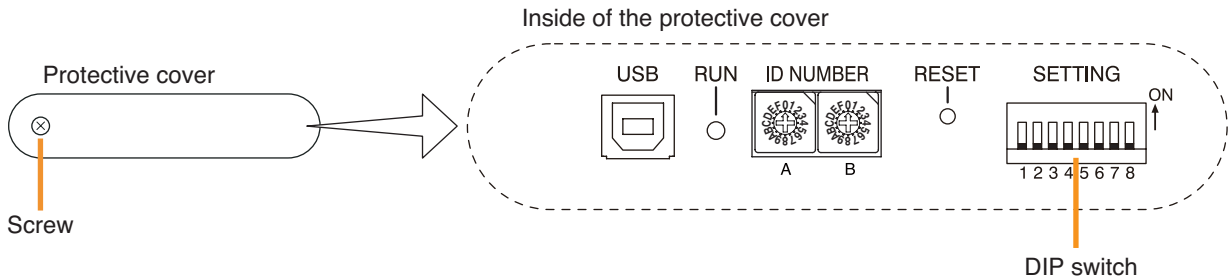

Note: DIP switch 1 is set to OFF by default.

Step 2. Set the switches.

2-1. If setting a key lock function:

Set DIP switch 1 to ON. When keys have been locked, the KEY LOCK indicator in the fluorescent display lights.

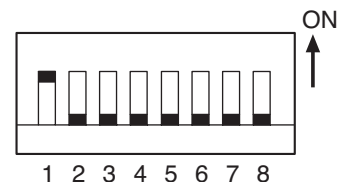

2-2. If canceling a key lock function:

Set DIP switch 1 to OFF. When key locking has been cancelled, the KEY LOCK indicator in the fluorescent display goes off.

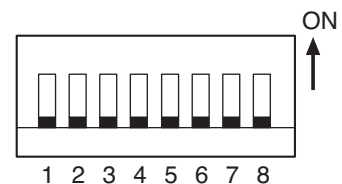

Step 3. Replace the protective cover.

3. OPERATING THE MENU SCREEN

Setting values can be confirmed or changed from the SX-2000AI's front panel.

3.1. Menu Screen Operation Keys

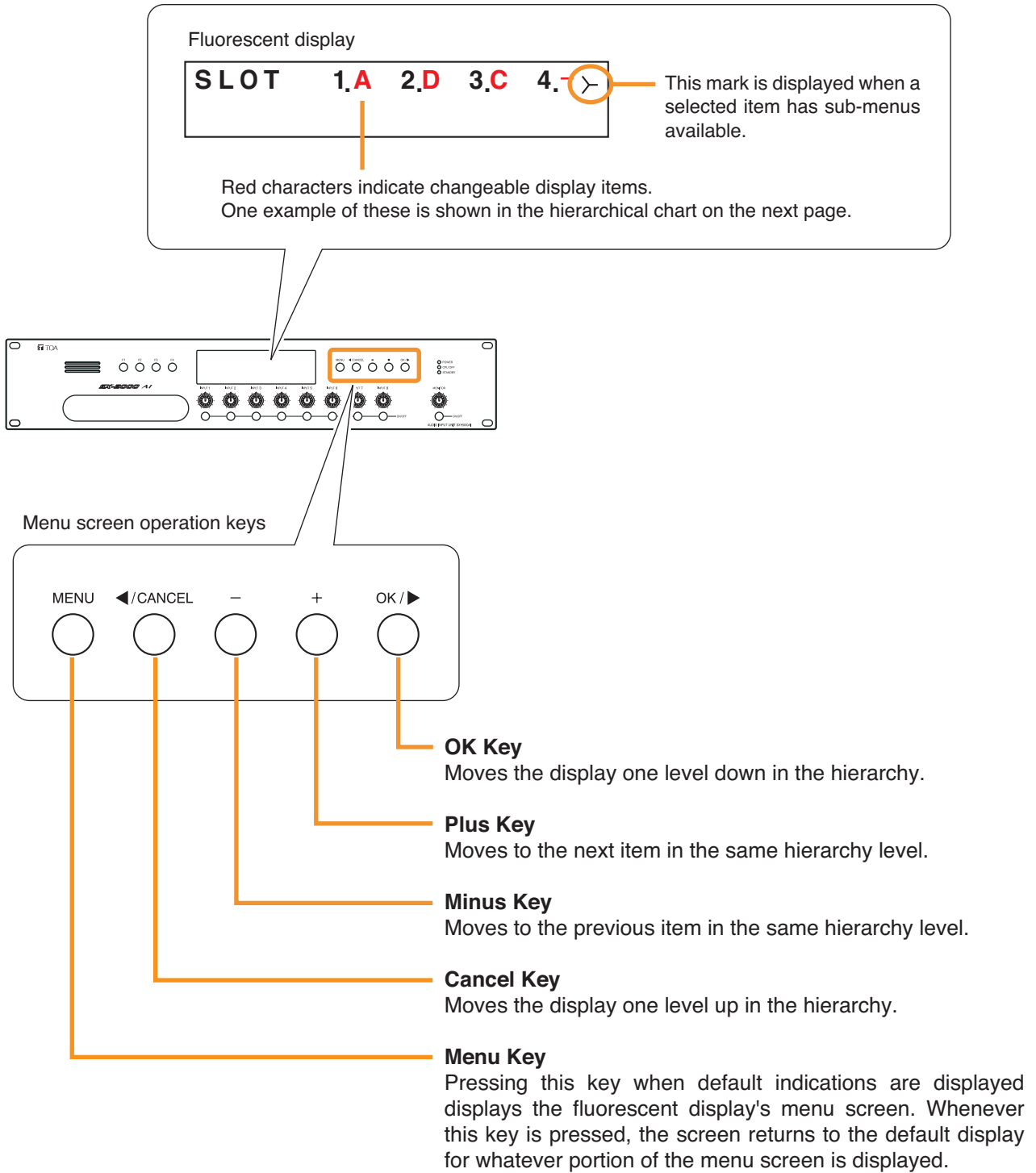

3.2. Menu Screen Hierarchical Chart

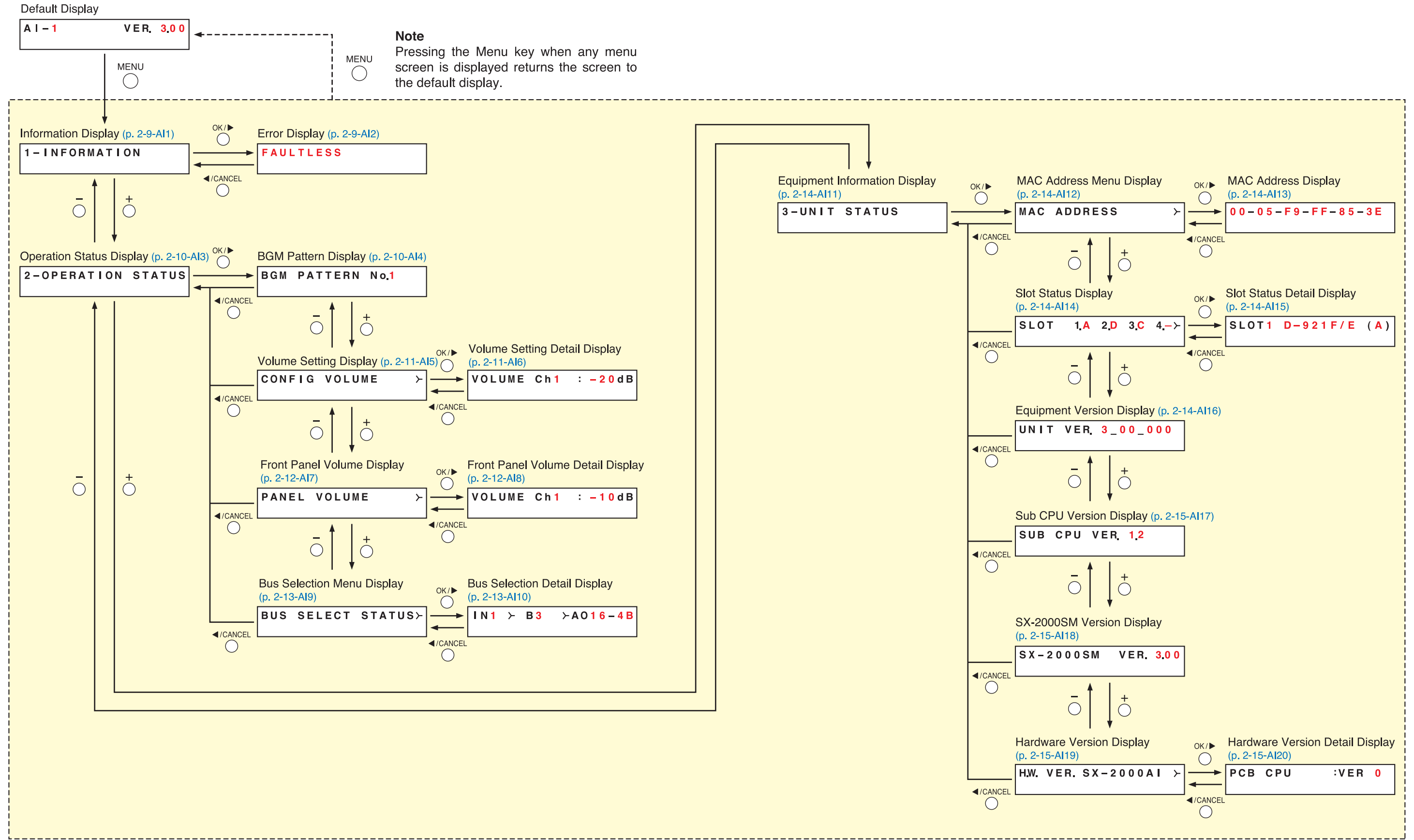

3.3. Explanations of Menu Screen Items

3.3.1. Information Display (AI1)

1 – I N F O R M A T I O N

Display screen for menu item "Information."

[Error Display (AI2)]

When any of the Fault indicators on the SX-2000SM's front panel is flashing, or when the Fault indicator or COM indicator on the SX-2000AI's fluorescent display is flashing, a brief error message appears in the text display area as shown below.

FAULTLESS

No abnormality or failure is detected.
(Fault and COM indicators: Off)

COMPONENT ERROR

Incorrect system configuration* is detected.
(Fault indicator: Flashing)

* When the system or module configuration differs from the contents set by the SX-2000 Setting Software.

FAULT DETECTED

System failure is detected. (e.g. The RM-200SA's microphone has failed.)
(Fault indicator: Flashing)

SX LINK COM FAULT

Communications error* is detected.
(Fault and COM indicators: Flashing)

* The SX-2000AI cannot communicate with the SX-2000SM.

Note

Contents of failure or abnormality can be confirmed by using the log data stored in the SX-2000SM.
(See [p. 1-5.](#))

3.3.2. Operation Status Display (AI3)

2 - OPERATION STATUS

Display screen for menu item "Operation Status."

[BGM Pattern Display (AI4)]

BGM PATTERN No.1

Displays the pattern number for a BGM broadcast in progress.

When this screen is displayed, the Input ON/OFF indicator on the fluorescent display is as follows:

Indicates the unit's operating status when the corresponding function keys (F1 to F4) are pressed. The indicator state differs depending on the function assigned to each function key as follows.

Function assigned to the function key	Display
Change or end the BGM pattern	Unlit: When the BGM pattern assigned to the function key is not being broadcast Lights: When the BGM pattern assigned to the function key is being broadcast
General-purpose broadcast pattern	Unlit: When the function key is OFF Flashes: When the function key is ON

COM
FAULT

FADER OL 0 -10 -20 -30 -40

LEVEL

KEYLOCK EMERGENCY

1 2 3 4 5 6 7 8

LEVEL OL 0 -10 -20 -30 -40

[Volume Setting Display (AI5), Volume Setting Detail Display (AI6)]

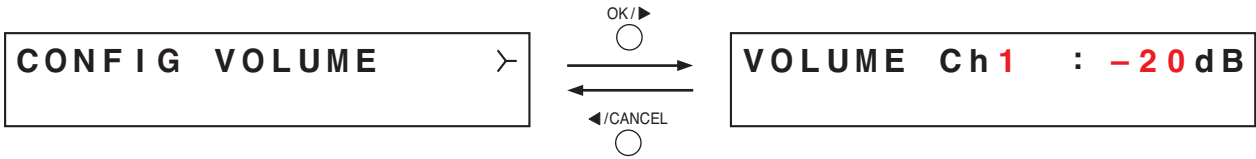

Indicates the input volume level set using the SX-2000 Setting Software in the input level meter. Besides, on the Volume Setting Detail Display screen, the set value for each input channel can be confirmed. Pressing the plus key increases the channel number by one and displays the setting value for that channel. Pressing the minus key decreases the channel number by one and displays the setting value for that channel.

When these screens are displayed, the entire fluorescent display is as follows:

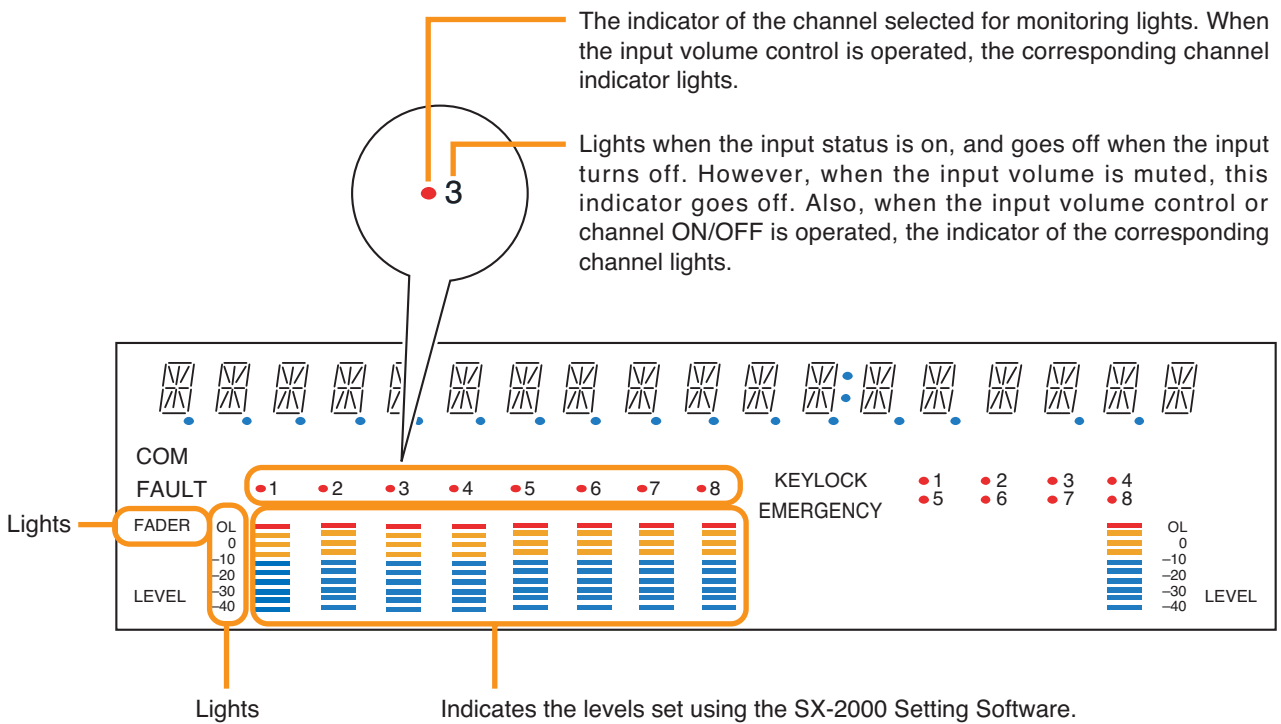

[Front Panel Volume Display (A17), Front Panel Volume Detail Display (A18)]

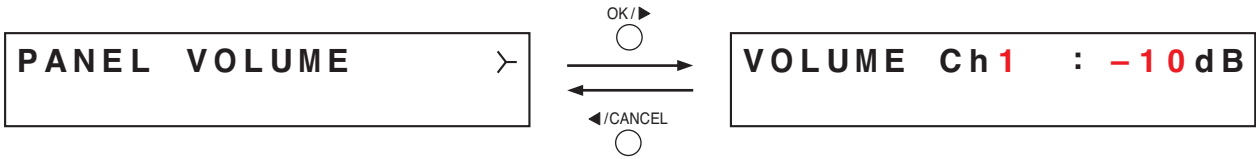

Indicates the input volume level set using the front panel's input volume control in the input level meter. Besides, on the Volume Setting Detail Display screen, the set value for each input channel can be confirmed. Pressing the plus key increases the channel number by one and displays the setting value for that channel. Pressing the minus key decreases the channel number by one and displays the setting value for that channel.

When these screens are displayed, the entire fluorescent display is as follows:

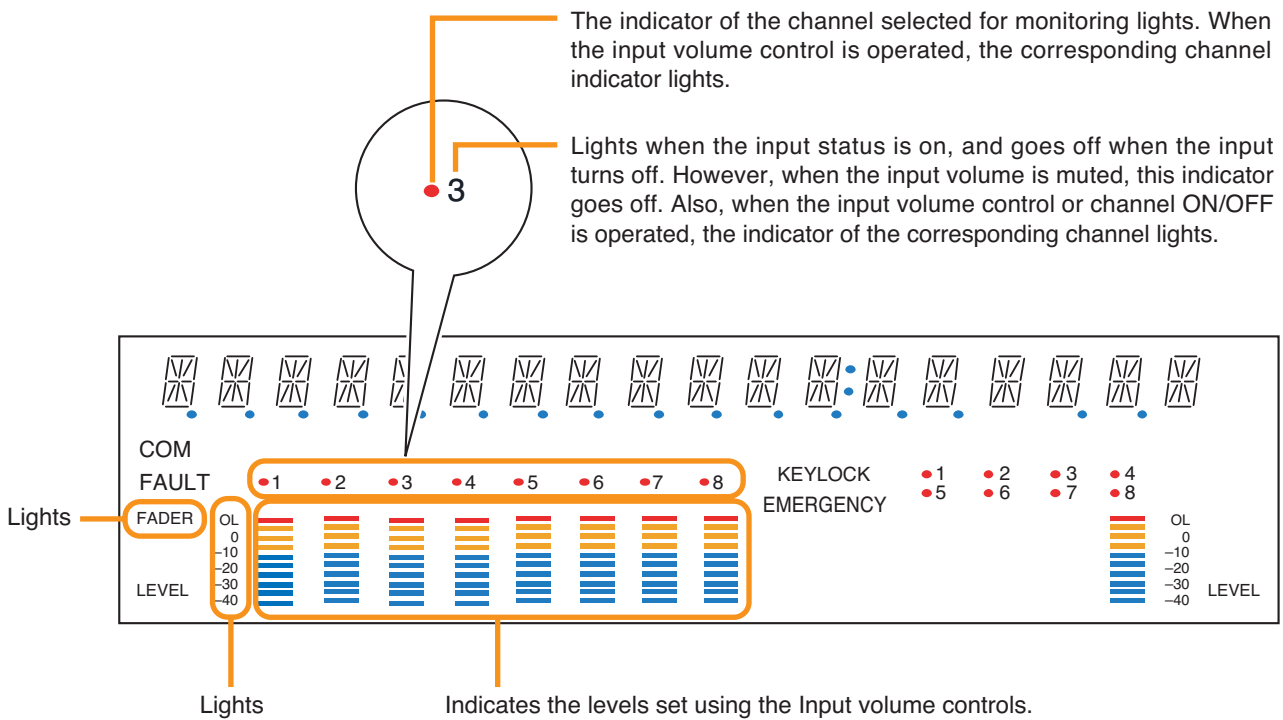

[Bus Selection Menu Display (AI9), Bus Selection Detail Display (AI10)]

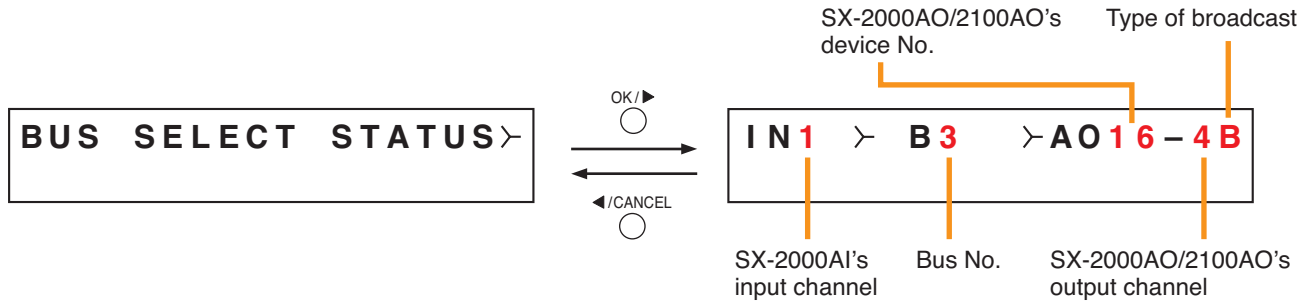

A "bus" is a path through which audio signals pass. The SX-2000 system has 16 bus lines. The Bus Selection Detail Display shows which bus is used to send a broadcast in progress and which output of the SX-2000AO/2100AO it is sent to. If there are two or more output destinations, only the smallest output channel number is shown first, and this can be switched over to other output destinations by pressing the OK key.

Pressing the plus key increases the input channel number by one and displays the broadcast status for that channel.

Pressing the minus key decreases the input channel number by one and displays the broadcast status for that channel.

Regarding the type of broadcast, "B" is displayed for BGM broadcasts, and "P" is displayed for general-purpose broadcasts or emergency broadcasts. For input channels not making broadcasts, the indication "--" is displayed for bus No., for the SX-2000AO/2100AO's device No., for the SX-2000AO/2100AO's output channel, and for the type of broadcast.

When these screens are displayed, the entire fluorescent display is as follows:

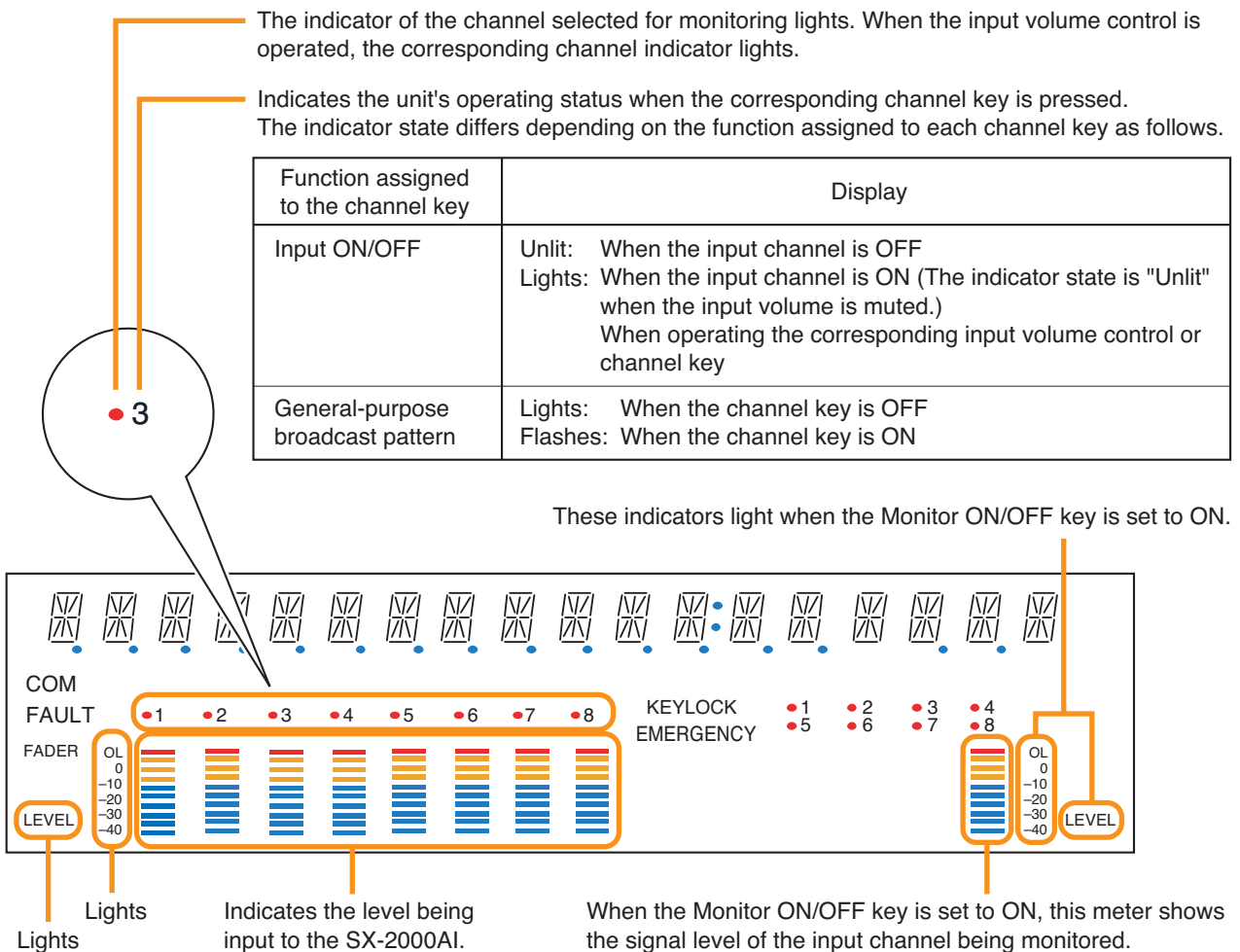

3.3.3. Equipment Information Display (AI11)

3 - UNIT STATUS

Display screen for menu item "Equipment Information."

[MAC Address Menu Display (AI12), MAC Address Display (AI13)]

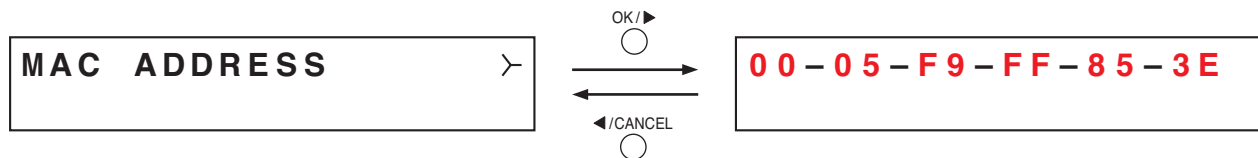

Displays the MAC address* set to the SX-2000AI on the Mac Address Display screen.

* A 12-digit hexadecimal address inherently assigned to and unique to a networking device.

[Slot Status Display (AI14), Slot Status Detail Display (AI15)]

Characters that represent module model numbers.

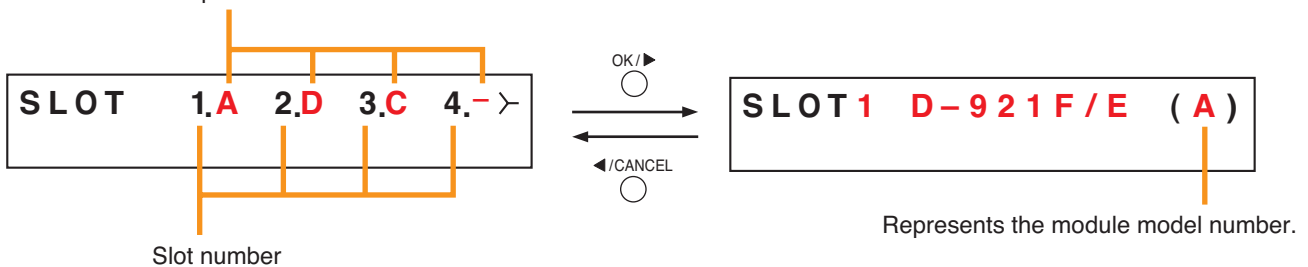

Displays which module is installed in the SX-2000AI's rear panel slots 1 – 4.

Alphabets A – D represent module model numbers as shown below.

- A: D-921F and D-921E
- B: D-922F and D-922E
- C: D-936R
- D: SX-200RM
- : Module is not installed.

The Slot Status Detail Display shows which module is installed in the SX-2000AI's rear panel slots 1 – 4 using a model number for each slot. Slots with no installed module are displayed as "BLANK."

Pressing the plus key increases the slot number by one and displays information for that slot number.

Pressing the minus key decreases the slot number by one and displays information for that slot number.

[Equipment Version Display (AI16)]

UNIT VER. 3_00_000

Displays the SX-2000AI's firmware version.

[Sub CPU Version Display (AI17)]

SUB CPU VER. 1.2

Displays the version of software related to operations and displays on the SX-2000AI's front panel.

[SX-2000SM Version Display (AI18)]

SX-2000SM VER. 3.00

Displays SX-2000SM firmware version.

It appears when the communication with the SX-2000SM is complete. Before that, "Ver.-- --" is displayed on the version display section.

[Hardware Version Display (AI19), Hardware Version Detail Display (AI20)]

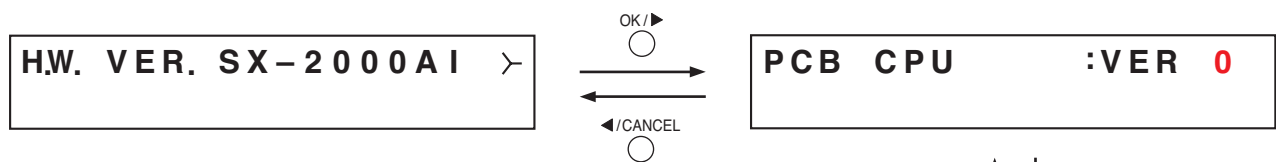

Displays the hardware version for each circuit board comprising the SX-2000AI unit.

In the screens of Hardware Version Detail Display, pressing the plus or minus key advances or reverses the screen.

- PCB CPU: Displays the CPU circuit board version.
- PCB FRONT: Displays the front circuit board version.
- PCB POWER: Displays the power supply circuit board version.
- PCB MOTHER: Displays the motherboard version.
- PCB ANALOG: Displays the analog circuit board version.

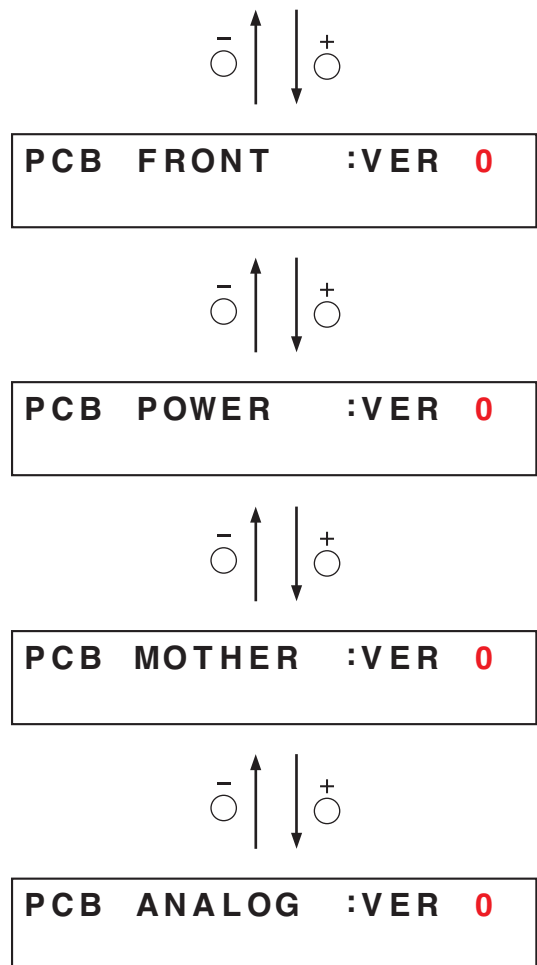

Chapter 3

SX-2100AI AUDIO INPUT UNIT

The SX-2100AI is an audio input unit for use with the SX-2000 system. It features modular construction that allows it to handle from 2 to 8 inputs per unit. It is equipped with 16 control inputs and 16 control outputs. It can be mounted in an EIA equipment rack (2U size*), and multiple units can be installed in different locations with no need to centralize in one location.

The SX-2100AI transmits audio signals to the SX-2000AO or SX-2100AO Audio Output Units by means of digital transmission in normal operating condition. However, if no general broadcasts can be made due to system failures, the SX-2100AI uses an analog transmission path to transmit audio signals, enabling all-zone calls to be made (referred to as "general urgency all-call" in this manual).

The SX-2100AI is equipped with 2 power inputs, allowing the connection of a backup power supply for use during power failures. Level meters provided for each input channel allow monitoring of audio input levels. Input volumes can be adjusted using the input volume controls on the front panel, however the maximum volume when the volume control knob is rotated fully clockwise is a default value defined by the SX-2000 Setting Software.

Also, any input channel can be monitored using the internal speaker. The key lock function, designed to prevent accidental mistaken operation, can disable input volume control and channel key settings.

* 1U size = 44.5 mm (standard size)

1. NOMENCLATURE AND FUNCTIONS

[Front]

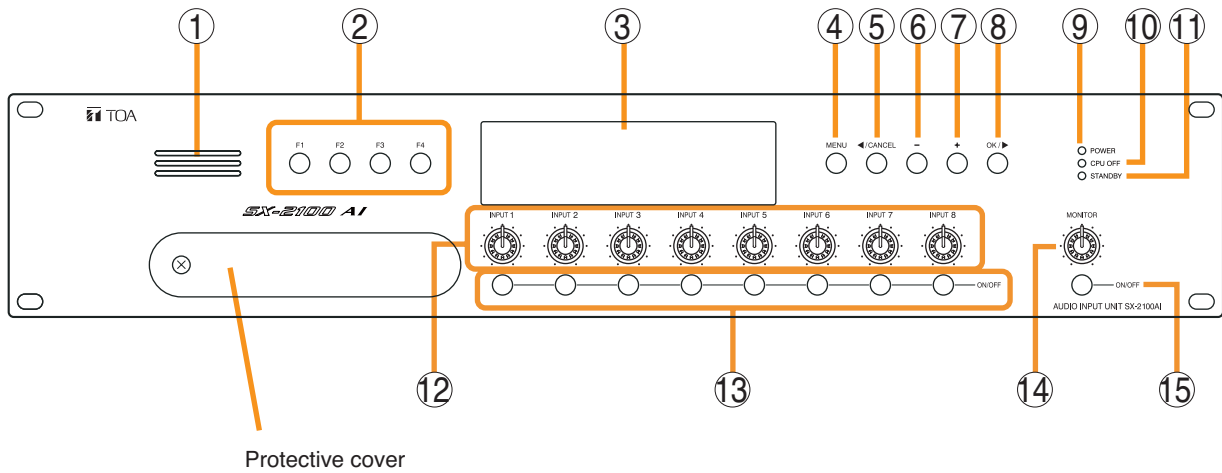

Inside of the protective cover

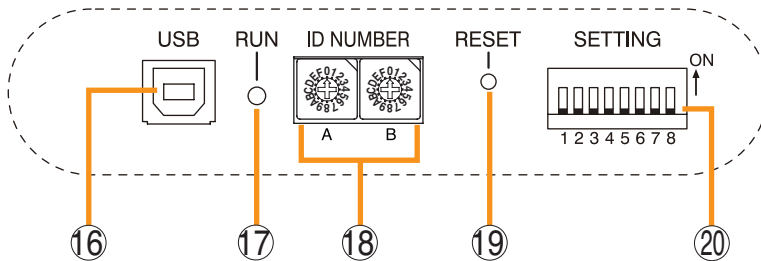

1. Monitor Speaker

Allows any input channel to be monitored.

2. Function Keys [F1, F2, F3, F4]

Pressing a function key executes the function that has been assigned to that key using the SX-2000 Setting Software. (See the separate Setting Software Instructions, "Event Settings.")

3. Fluorescent Display

The default display shows device numbers and firmware versions.

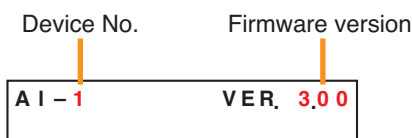

Displays the SX-2100AI's current operation status, input level, etc. (See p. 3-4.)

4. Menu Key [MENU]

Pressing this key displays the fluorescent display's menu screen. Whenever this key is pressed, the screen returns to the default display for whatever portion of the menu screen is displayed.

5. Cancel Key [◀/CANCEL]

Used to switch the menu screen.

6. Minus Key [-]

Used to switch the menu screen. When the Monitor ON/OFF Key (15) is set to ON, use this key to select which channel to monitor. The selected channel number decreases by one each time this key is pressed.

7. Plus Key [+]

Used to switch the menu screen. When the Monitor ON/OFF Key (15) is set to ON, use this key to select which channel to monitor. The selected channel number increases by one each time this key is pressed.

8. OK Key [OK/▶]

Used to switch the menu screen.

9. Power Indicator [POWER] (Blue)

Lights when the power is switched on.

10. CPU OFF Indicator [CPU OFF] (Red)

Lights while the general urgency all-call (CPU OFF state) is being made (p. 10-9).

11. Standby Indicator [STANDBY] (Green)

Lights while the unit is being initialized at power-on or at reset.

Flashes when the fluorescent display is in light shutoff mode and the light stays unlit.

Lights when the SX-2000 system is operating on the backup power supply during power failures.

12. Input Volume Controls [INPUT 1 – 8]

Adjust the input volume of each input channel. Rotating the control fully counterclockwise mutes the input sound source connected to that channel and causes the input ON/OFF indicator (28) on the fluorescent display to turn off.

When an input channel's "Type" is set to "Emergency" on the SX-2000 Setting software, the input signal source is made to bypass this Input volume control. (See the separate Setting Software Instructions, "System Settings.")

13. Channel Keys [ON/OFF]

Turn each input channel on or off. The input channel alternates between on and off each time this key is pressed.

Other functions can also be assigned to each key by using the SX-2000 Setting Software. (See the separate Setting Software Instructions, "Event Settings.")

When an input channel's "Type" is set to "Emergency" on the SX-2000 Setting software, the input signal source is made to bypass this Channel key. (See the separate Setting Software Instructions, "System Settings.")

14. Monitor Volume Control [MONITOR]

Adjusts the sound volume of the monitor speaker (1).

15. Monitor ON/OFF Key [ON/OFF]

Enables or disables the audio monitor function for the selected input channel. The monitor function alternates between on and off each time this key is pressed.

16. USB Port [USB]

This port is not used.

17. RUN Indicator [RUN] (Green)

Normally flashes continuously.

18. ID Switch [ID NUMBER]

Sets the SX-2100AI's device number. (See the separate Installation Manual, "Installation.")

19. Reset Key [RESET]

Pressing this key resets the SX-2100AI.

Notes

- Resetting the SX-2100AI stops broadcasts in a part of or all zones currently in progress via the reset SX-2100AI.
- Do not keep pressing the key for over 1 second. The unit cannot operate. If the unit operation is suspended, press the Reset key for less than one second again.

20. DIP Switch [SETTING]

Performs key lock function settings. (See [p. 3-6](#).)

• Switch 1

ON: Disables operation of the front panel input volume controls and channel keys.

OFF: Cancels key lock status.

• Switches 2 – 8

These switches are not used.

Note

Switches 1 – 8 are set to the OFF position by default.

[Fluorescent Display]

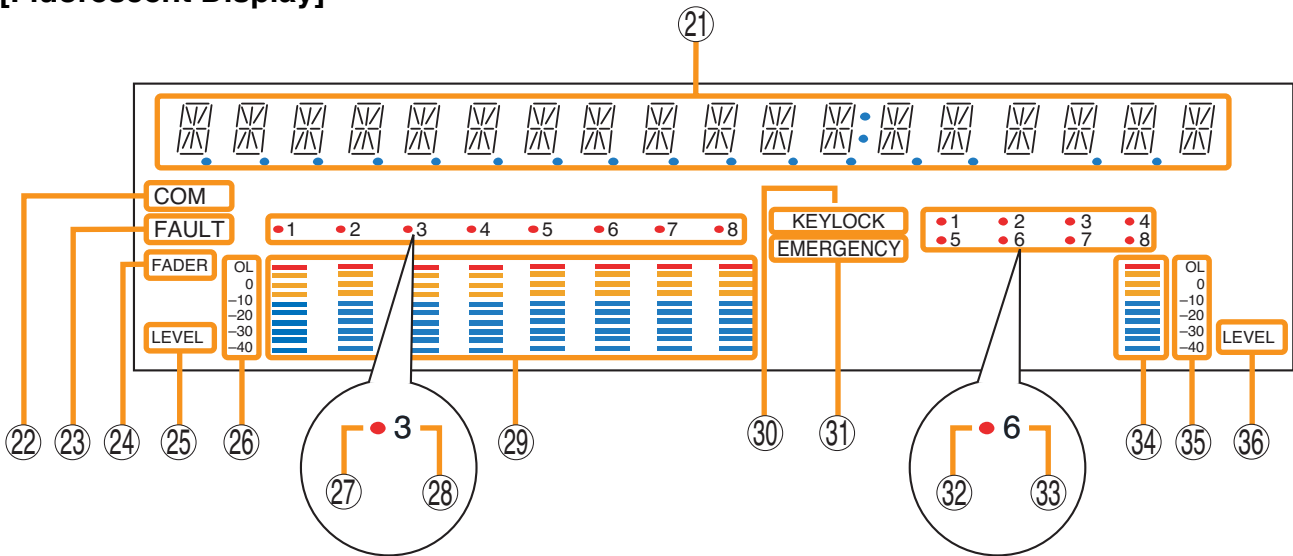

Notes

- A timer-activated light shutoff function can be set for the fluorescent display using the SX-2000 Setting Software. (See the separate Setting Software Instructions, "Basic Settings.") When the light shutoff function has been set, if the SX-2100AI is not operated for 5 minutes or more, the fluorescent display's light goes off and the standby indicator (11) begins to flash. Pressing any keys other than the function keys on the front panel resets the screen display.
- Normally, the fluorescent display's light goes off at the time of the power failure.
- While the SX-2000 system is in an emergency condition, the fluorescent display's light does not go off even if the power fails.

21. Text Display Area

Displays the menu screen information when the corresponding function key is pressed.

22. COM Indicator [COM]

Flashes to indicate a communications error.

23. Fault Indicator [FAULT]

Flashes when a system failure, incorrect system configuration* or communications error is detected. This indicator continues to flash until failure conditions return to normal.

* When the system or module configuration differs from the contents set by the SX-2000 Setting Software.

24. Input Level Meter Fader Indicator [FADER]

Lights when the input level meter indicates the sound volume set using the SX-2000 Setting Software or input volume control.

25. Input Level Meter Level Indicator [LEVEL]

Lights when the input level meter indicates the level being input to the SX-2100AI.

26. Input Level Meter Scale

27. Input Indicator

The input channel to be monitored lights red.

28. Input ON/OFF Indicator

Indicates the unit's operating status when the corresponding channel key is pressed.

The indicator state differs depending on the function assigned to each channel key as follows.

Function assigned to the channel key	When ON	When OFF
Input ON/OFF	Lights*	Unlit
General-purpose pattern broadcast's activation and termination	Flashes	Lights

* The indicator state is "Unlit" when the input volume is muted.

29. Input Level Meter

Indicates the actual level or a set volume value on each input channel.

30. Key Lock Indicator [KEY LOCK]

Lights when the input volume controls and channel keys are all locked. (See p. 3-6, "Key Lock Settings and Cancellation.")

31. Emergency Indicator [EMERGENCY]

Lights when the SX-2000 system is in an emergency condition.

32. Remote Microphone Output Status Indicator

Lights red continuously as long as announcements are made from the RM-200SF, RM-200SA, or RM-210 Remote Microphone.

33. Remote Microphone Connection Status Indicator

The device number of the Remote Microphone connected to the SX-2100AI lights.

34. Monitor Level Meter

Indicates the sound volume level of the input channel being monitored.

35. Monitor Level Meter Scale

Lights when the Monitor ON/OFF Key (15) is set to ON.

36. Monitor ON/OFF Indicator [LEVEL]

Lights when the Monitor ON/OFF Key (15) is set to ON.

2. KEY LOCK SETTINGS AND CANCELLATION (DIP Switch 1 Operation)

It is possible to disable the input volume controls, and channel keys in order to prevent mistaken operation. The input volume level set while the key lock function is used takes effect after the key lock has been released.

Note

When the SX-2000 system is placed in an emergency condition during key lock OFF, the emergency sound level preset with the front-mounted volume control knob is invalid, but that defined by the SX-2000 Setting Software is valid.

During key lock ON, however, the volume level set with the input volume control knob is valid even if the SX-2000 system is placed in an emergency condition. Before setting key lock function to ON, be sure to adjust the input volume control knob corresponding to the emergency source channel for a proper sound level.

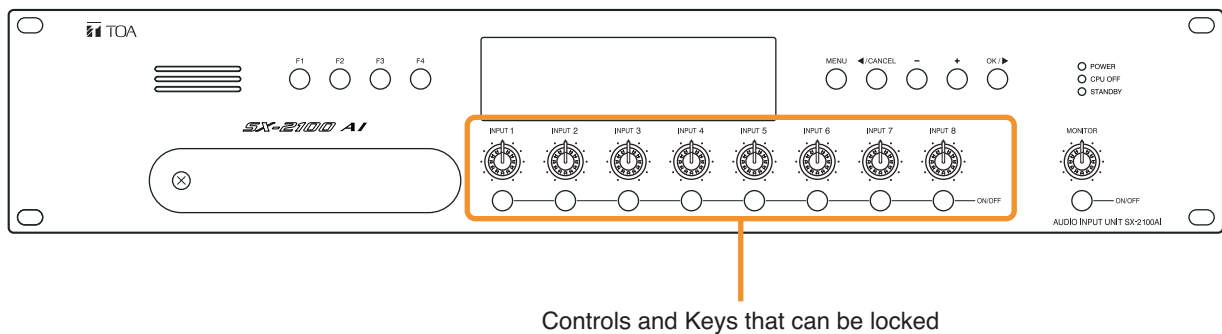

Step 1. Remove the protective cover on the SX-2100AI's front panel by unscrewing it with a Phillips screwdriver.

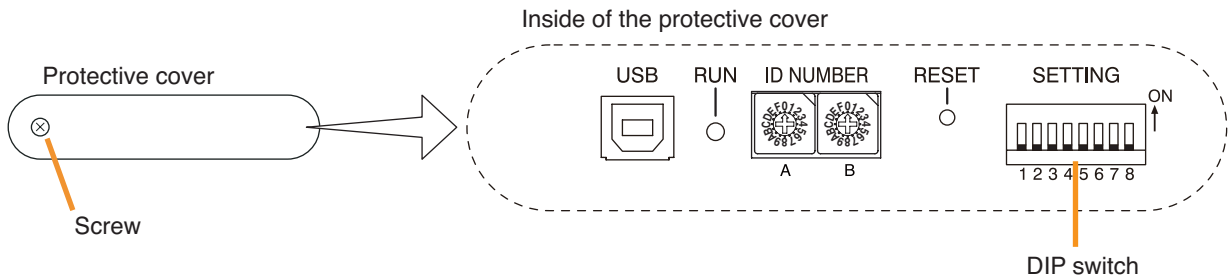

Step 2. Set the switches.

Note: DIP switch 1 is set to OFF by default.

2-1. If setting a key lock function:

Set DIP switch 1 to ON. When keys have been locked, the KEY LOCK indicator in the fluorescent display lights.

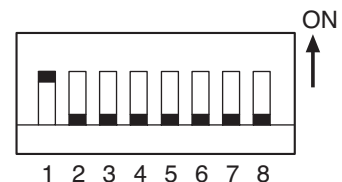

2-2. If canceling a key lock function:

Set DIP switch 1 to OFF. When key locking has been cancelled, the KEY LOCK indicator in the fluorescent display goes off.

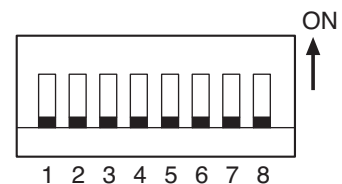

Step 3. Replace the protective cover.

3. OPERATING THE MENU SCREEN

Setting values can be confirmed or changed from the SX-2100AI's front panel.

3.1. Menu Screen Operation Keys

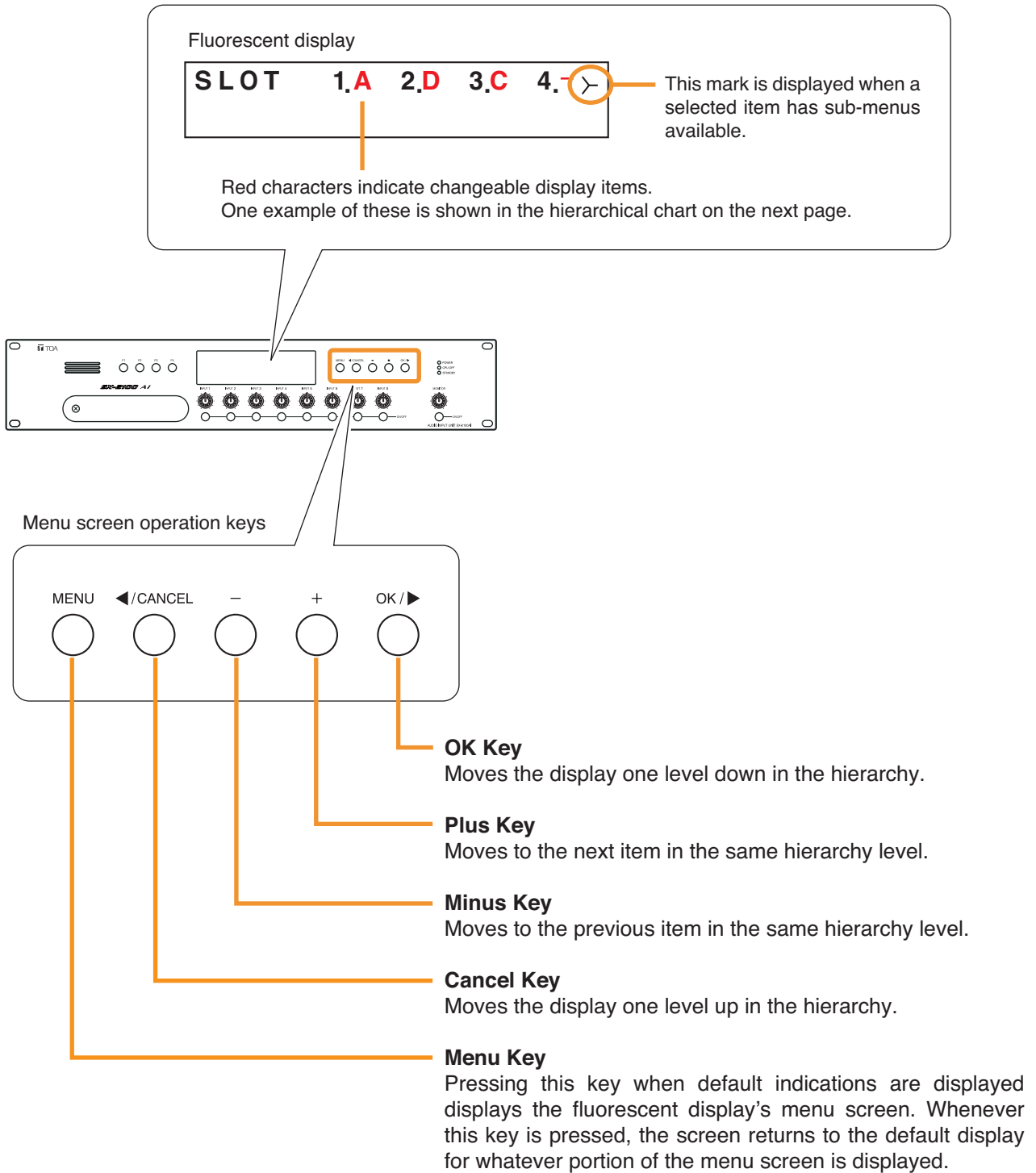

3.2. Menu Screen Hierarchical Chart

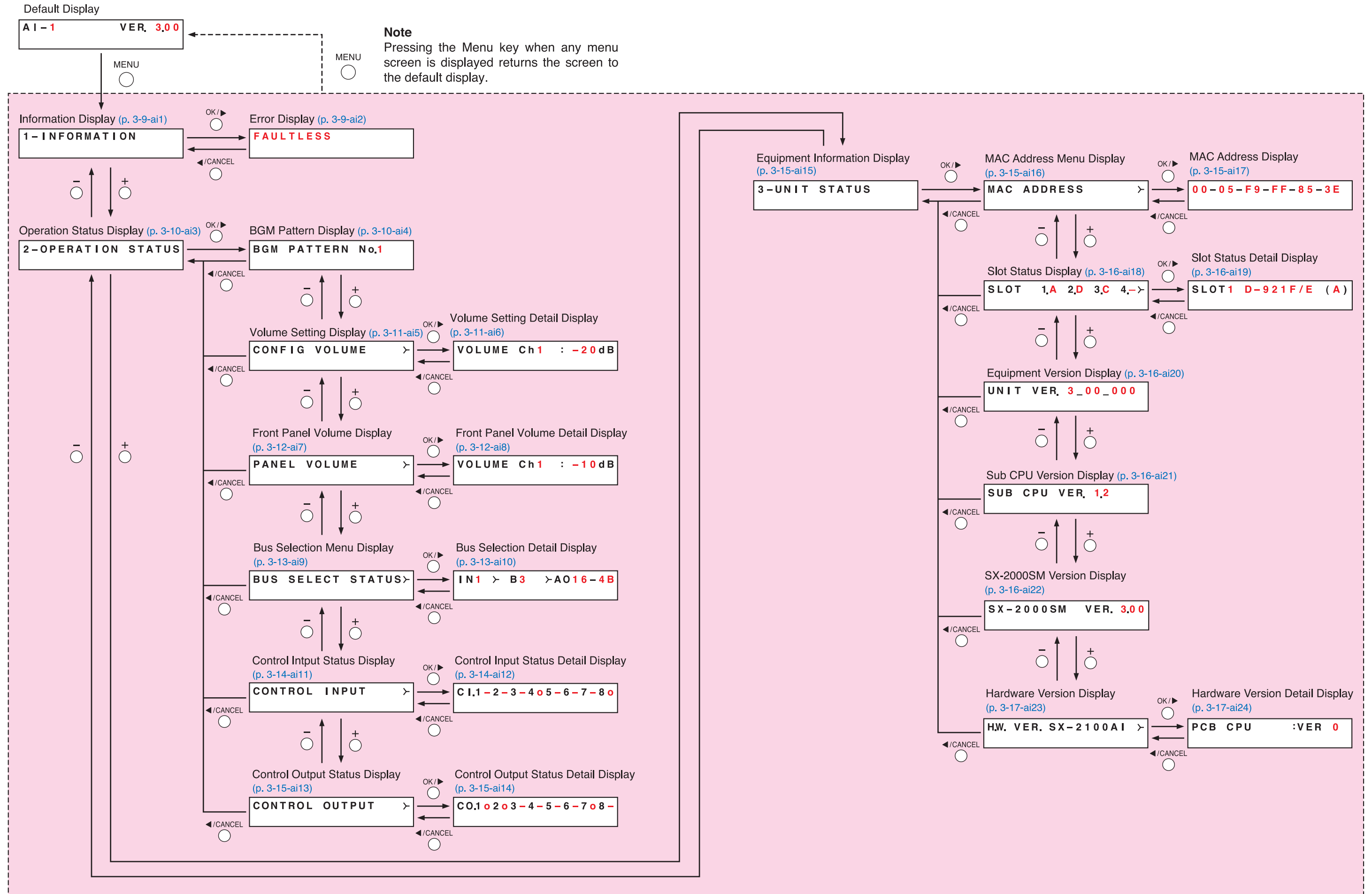

3.3. Explanations of Menu Screen Items

3.3.1. Information Display (ai1)

1 – I N F O R M A T I O N

Display screen for menu item "Information."

[Error Display (ai2)]

When any of the Fault indicators on the SX-2000SM's front panel is flashing, or when the Fault indicator or COM indicator on the SX-2100AI's fluorescent display is flashing, a brief error message appears in the text display area as shown below.

FAULTLESS

No abnormality or failure is detected.
(Fault and COM indicators: Off)

COMPONENT ERROR

Incorrect system configuration* is detected.
(Fault indicator: Flashing)

* When the system or module configuration differs from the contents set by the SX-2000 Setting Software.

FAULT DETECTED

System failure is detected. (e.g. The RM-200SA's microphone has failed.)
(Fault indicator: Flashing)

SX LINK COM FAULT

Communications error* is detected.
(Fault and COM indicators: Flashing)

* The SX-2100AI cannot communicate with the SX-2000SM.

Note

Contents of failure or abnormality can be confirmed by using the log data stored in the SX-2000SM.
(See [p. 1-5.](#))

3.3.2. Operation Status Display (ai3)

2 - OPERATION STATUS

Display screen for menu item "Operation Status."

[BGM Pattern Display (ai4)]

BGM PATTERN No.1

Displays the pattern number for a BGM broadcast in progress.

When this screen is displayed, the Input ON/OFF indicator on the fluorescent display is as follows:

Indicates the unit's operating status when the corresponding function keys (F1 to F4) are pressed.
The indicator state differs depending on the function assigned to each function key as follows.

Function assigned to the function key	Display
Change or end the BGM pattern	Unlit: When the BGM pattern assigned to the function key is not being broadcast Lights: When the BGM pattern assigned to the function key is being broadcast
General-purpose broadcast pattern	Unlit: When the function key is OFF Flashes: When the function key is ON

The diagram shows a fluorescent display panel with the following indicators:

- COM**: A row of 16 indicator lights.
- FAULT**: A row of 8 red LEDs labeled 1 through 8. LEDs 1, 2, 3, and 4 are highlighted with an orange circle and a callout '1'.
- FADER**: A row of 8 level meters, each with a scale from OL to -40.
- LEVEL**: A row of 8 level meters, each with a scale from OL to -40.
- KEYLOCK**: A row of 4 red LEDs labeled 1 through 4.
- EMERGENCY**: A row of 4 red LEDs labeled 5 through 8.

[Volume Setting Display (ai5), Volume Setting Detail Display (ai6)]

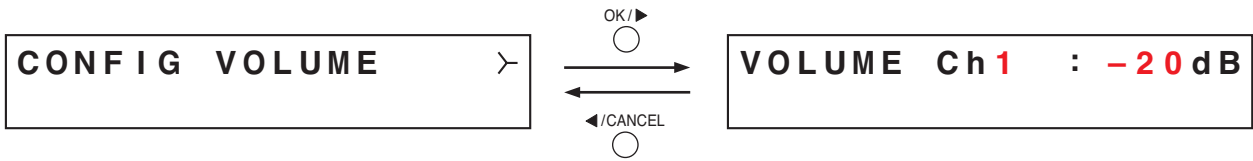

Indicates the input volume level set using the SX-2000 Setting Software in the input level meter. Besides, on the Volume Setting Detail Display screen, the set value for each input channel can be confirmed. Pressing the plus key increases the channel number by one and displays the setting value for that channel. Pressing the minus key decreases the channel number by one and displays the setting value for that channel.

When these screens are displayed, the entire fluorescent display is as follows:

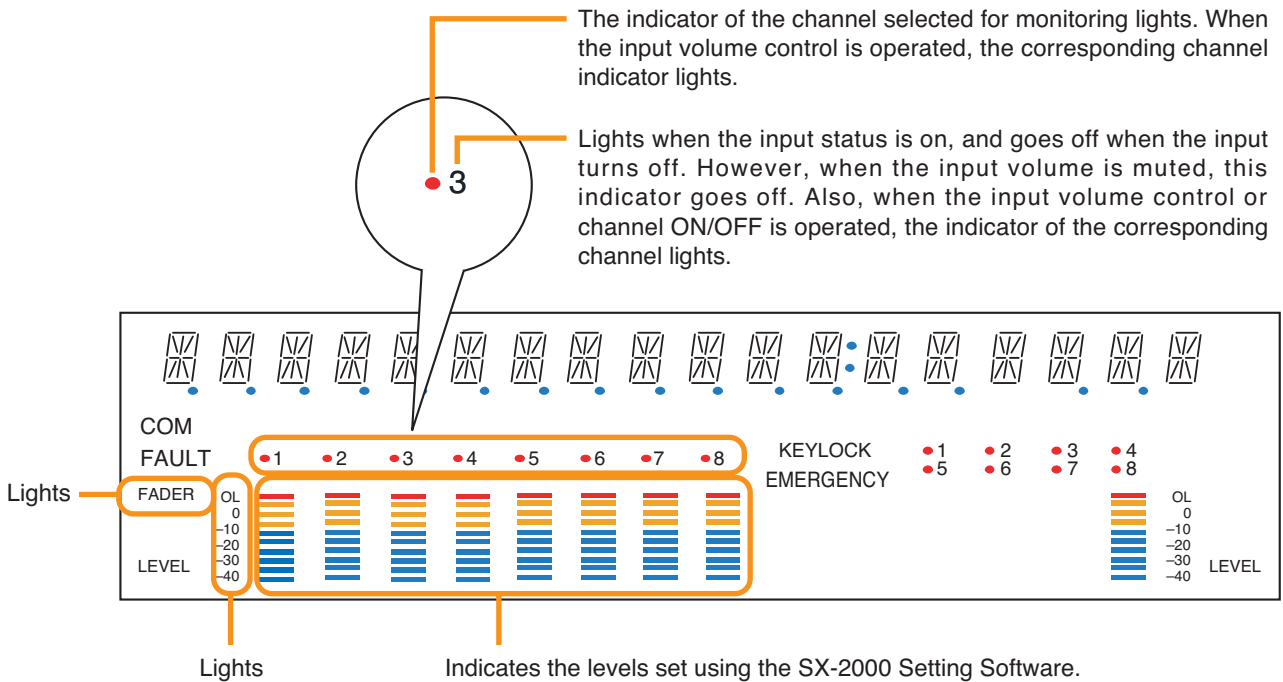

[Front Panel Volume Display (ai7), Front Panel Volume Detail Display (ai8)]

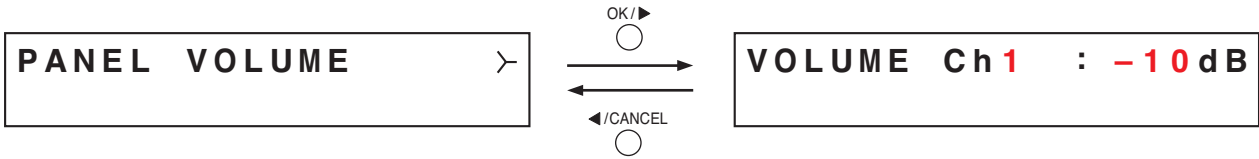

Indicates the input volume level set using the front panel's input volume control in the input level meter. Besides, on the Volume Setting Detail Display screen, the set value for each input channel can be confirmed. Pressing the plus key increases the channel number by one and displays the setting value for that channel. Pressing the minus key decreases the channel number by one and displays the setting value for that channel.

When these screens are displayed, the entire fluorescent display is as follows:

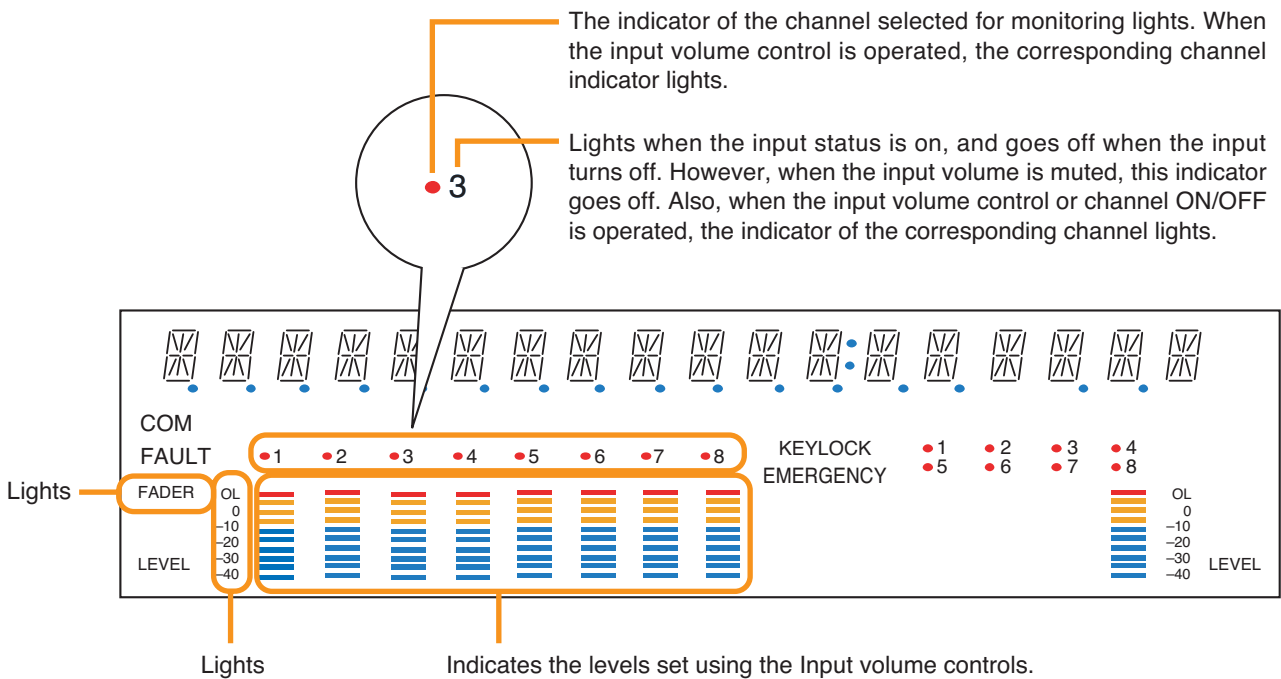

[Bus Selection Menu Display (ai9), Bus Selection Detail Display (ai10)]

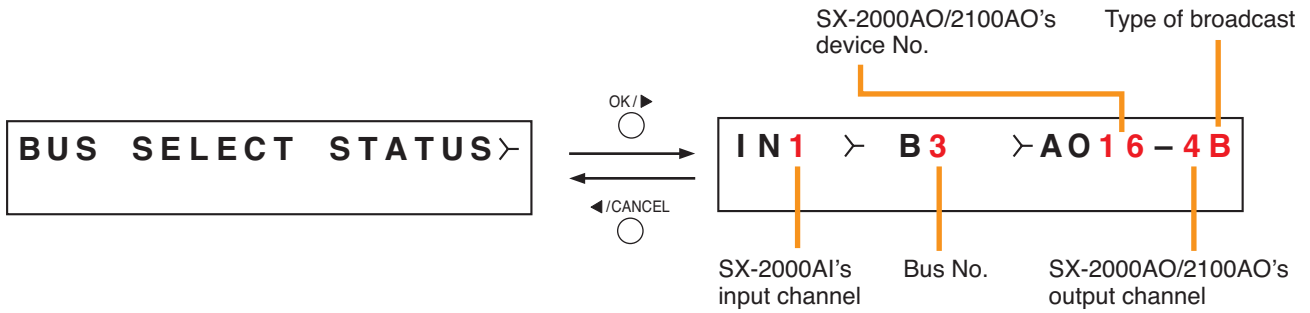

A "bus" is a path through which audio signals pass. The SX-2000 system has 16 bus lines. The Bus Selection Detail Display shows which bus is used to send a broadcast in progress and which output of the SX-2000AO/2100AO it is sent to. If there are two or more output destinations, only the smallest output channel number is shown first, and this can be switched over to other output destinations by pressing the OK key.

Pressing the plus key increases the input channel number by one and displays the broadcast status for that channel.

Pressing the minus key decreases the input channel number by one and displays the broadcast status for that channel.

Regarding the type of broadcast, "B" is displayed for BGM broadcasts, and "P" is displayed for general-purpose broadcasts or emergency broadcasts. For input channels not making broadcasts, the indication "--" is displayed for bus No., for the SX-2000AO/2100AO's device No., for the SX-2000AO/2100AO's output channel, and for the type of broadcast.

When these screens are displayed, the entire fluorescent display is as follows:

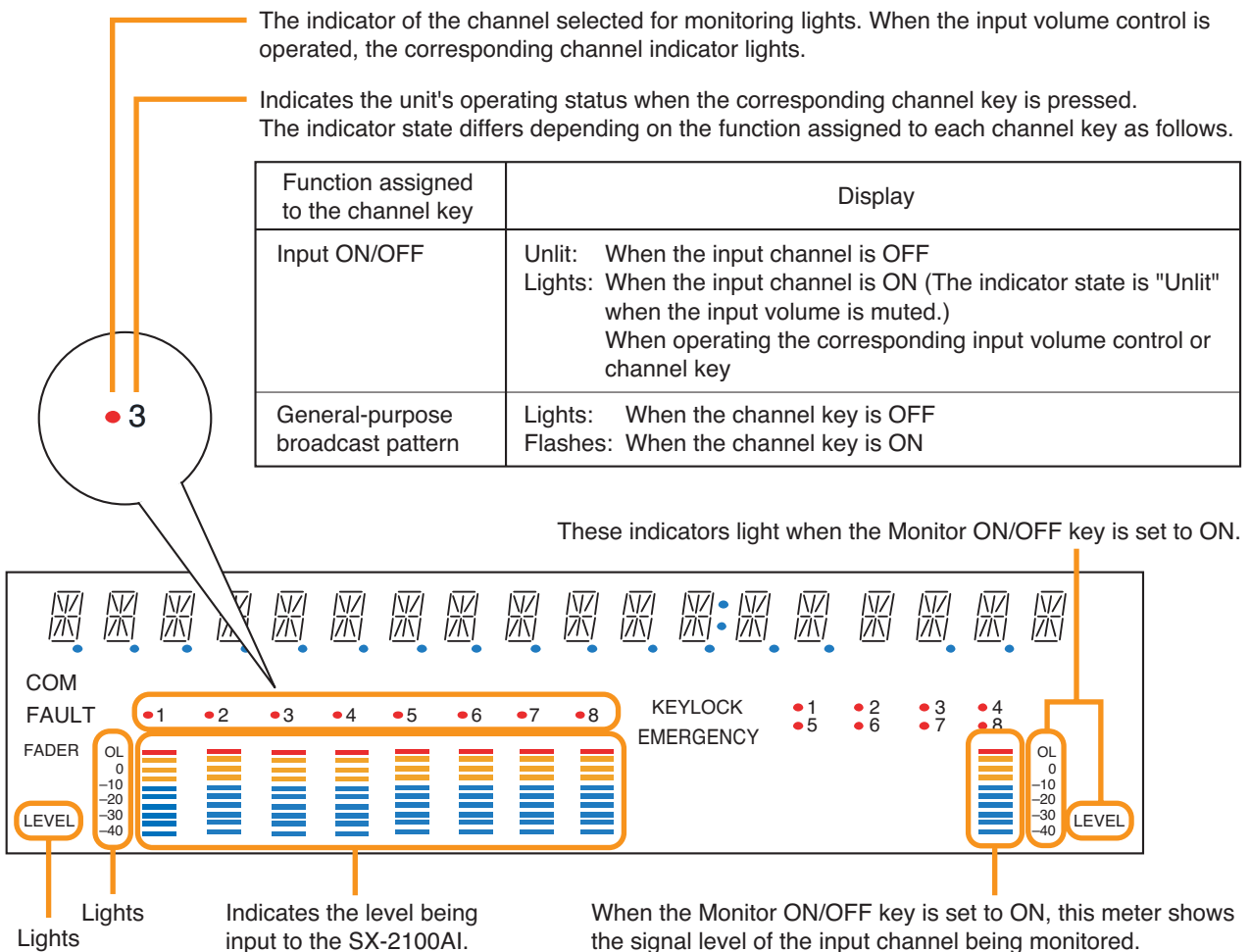

[Control Input Status Display (ai11), Control Input Status Detail Display (ai12)]

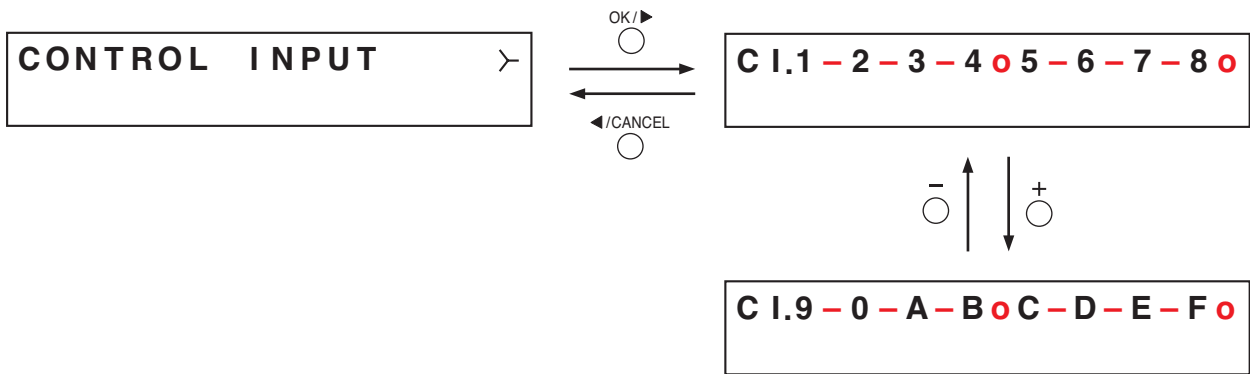

Control input number	Screen display
1	1
2	2
3	3
4	4
5	5
6	6
7	7
8	8

Control input number	Screen display
9	9
10	0
11	A
12	B
13	C
14	D
15	E
16	F

Displays the current control input status.

"o" is displayed when the control input is on, and "-" is displayed when the control input is off.

In the Control Input Status Detail Display screens, pressing the plus or minus key alternates the display between a group of Control input 1 – 8 and that of Control input 9 – 16 (alphabets A to F represent 11 to 16).

The control input numbers correspond to the screen displays as shown in the table above.

[Control Output Status Display (ai13), Control Output Status Detail Display (ai14)]

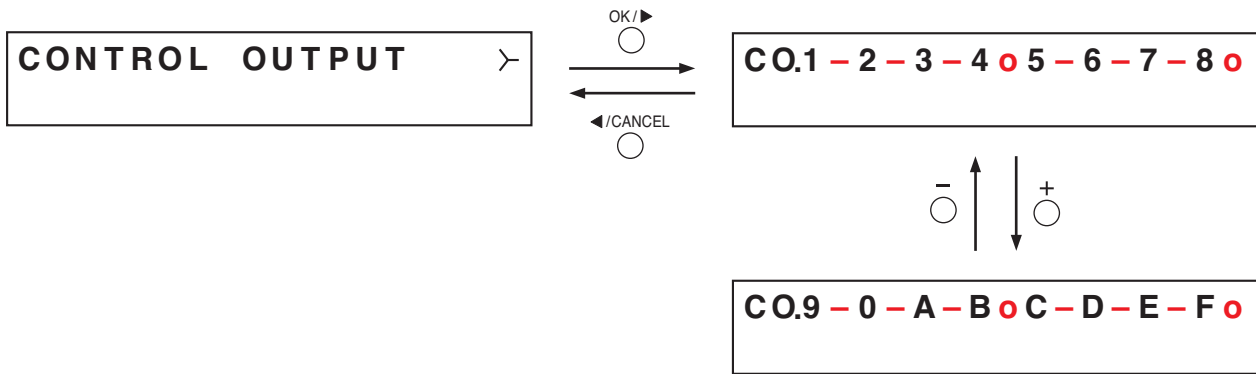

Control output number	Screen display	Control output number	Screen display
1	1	9	9
2	2	10	0
3	3	11	A
4	4	12	B
5	5	13	C
6	6	14	D
7	7	15	E
8	8	16	F

Displays the current control output status.

"o" is displayed when the control output is on, and "-" is displayed when the control output is off.

In the Control Output Status Detail Display screens, pressing the plus or minus key alternates the display between a group of Control output 1 – 8 and that of Control output 9 – 16 (alphabets A to F represent 11 to 16).

The control output numbers correspond to the screen displays as shown in the table above.

3.3.3. Equipment Information Display (ai15)



Display screen for menu item "Equipment Information."

[MAC Address Menu Display (ai16), MAC Address Display (ai17)]

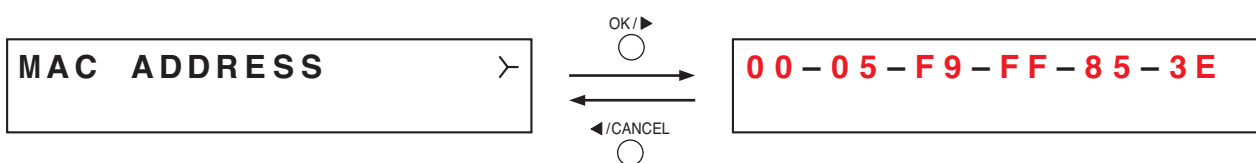

Displays the MAC address* set to the SX-2100AI on the Mac Address Display screen.

* A 12-digit hexadecimal address inherently assigned to and unique to a networking device.

[Slot Status Display (ai18), Slot Status Detail Display (ai19)]

Characters that represent module model numbers.

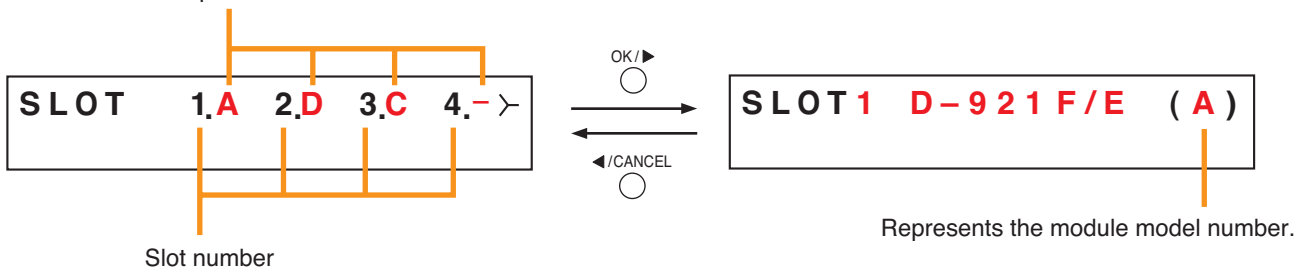

Displays which module is installed in the SX-2100AI's rear panel slots 1 – 4.

Alphabets A – D represent module model numbers as shown below.

- A: D-921F and D-921E
- B: D-922F and D-922E
- C: D-936R
- D: SX-200RM
- : Module is not installed.

The Slot Status Detail Display shows which module is installed in the SX-2100AI's rear panel slots 1 – 4 using a model number for each slot. Slots with no installed module are displayed as "BLANK."

Pressing the plus key increases the slot number by one and displays information for that slot number.

Pressing the minus key decreases the slot number by one and displays information for that slot number.

[Equipment Version Display (ai20)]

UNIT VER. 3 _ 00 _ 000

Displays the SX-2100AI's firmware version.

[Sub CPU Version Display (ai21)]

SUB CPU VER. 1.2

Displays the version of software related to operations and displays on the SX-2100AI's front panel.

[SX-2000SM Version Display (ai22)]

SX-2000SM VER. 3.00

Displays SX-2000SM firmware version.

It appears when the communication with the SX-2000SM is complete. Before that, "Ver.-- --" is displayed on the version display section.

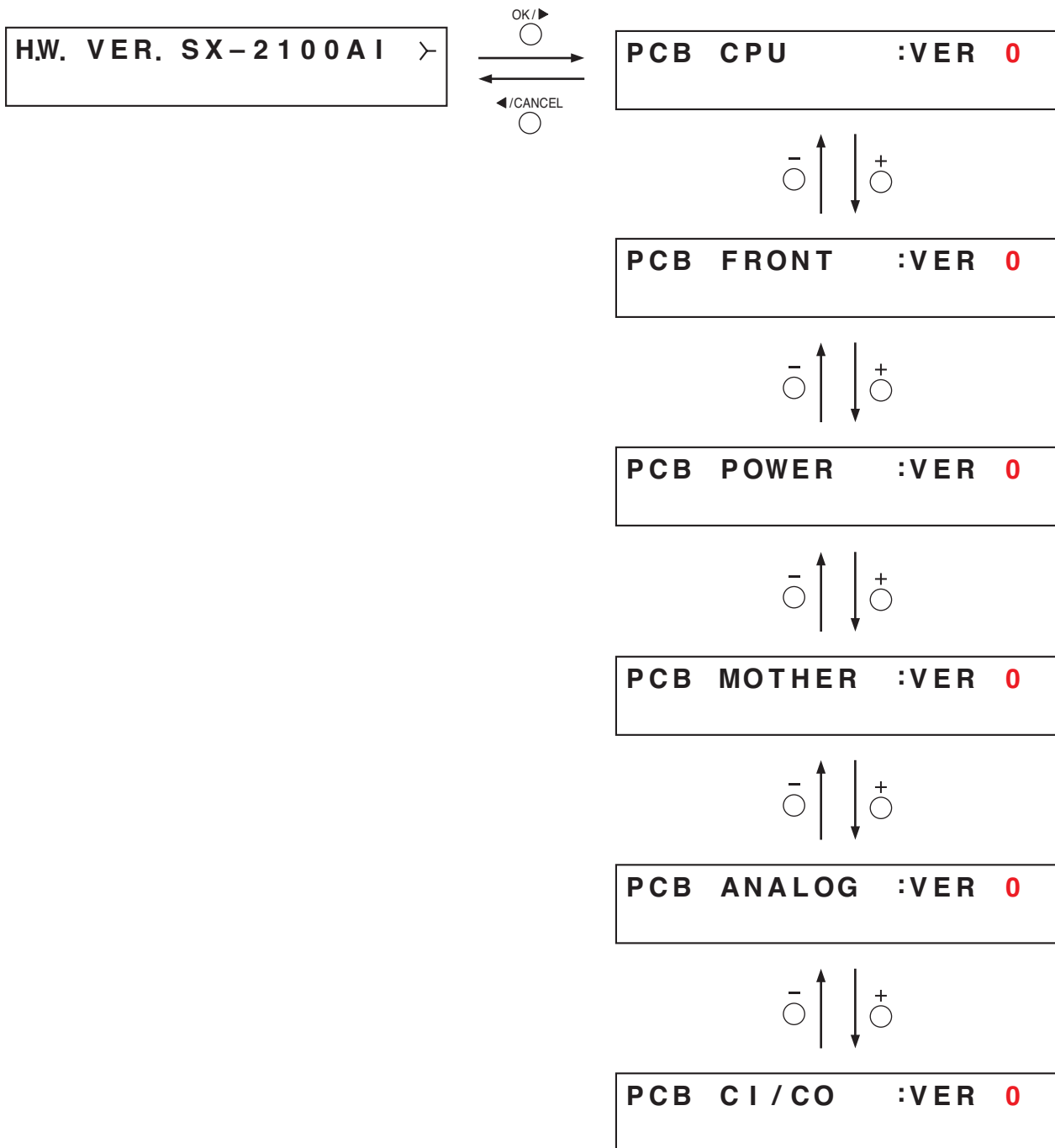
[Hardware Version Display (ai23), Hardware Version Detail Display (ai24)]

Displays the hardware version for each circuit board comprising the SX-2100AI unit.

In the screens of Hardware Version Detail Display, pressing the plus or minus key advances or reverses the screen.

- PCB CPU: Displays the CPU circuit board version.
- PCB FRONT: Displays the front circuit board version.
- PCB POWER: Displays the power supply circuit board version.
- PCB MOTHER: Displays the motherboard version.
- PCB ANALOG: Displays the analog circuit board version.
- PCB CI/CO: Displays the CI/CO circuit board version.

Chapter 4

SX-2000AO AUDIO OUTPUT UNIT

The SX-2000AO is an audio output unit for use with the SX-2000 system. It is equipped with 8 audio outputs, 8 control inputs, and 8 control outputs. In addition, one each of the SX-2000CI Control Input Unit and SX-2000CO Control Output Unit can be cascade-connected to the SX-2000AO, allowing the number of SX-2000 system's control inputs and outputs to be increased. The SX-2000AO also features an emergency audio input and a 24 V emergency cutoff input*¹ which permits the SX-2000AO to be used in conjunction with an emergency broadcast system. It can be mounted in an EIA equipment rack (2U size*²), and multiple units can be installed in different locations with no need to centralize in one location.

Two inputs can be mixed and output. The SX-2000AO receives audio signals from the SX-2000AI or SX-2100AI Audio Input Unit by means of digital transmission in normal operating condition. However, if no general broadcasts can be made due to system failures, the SX-2000AO uses an analog transmission path to receive audio signals, enabling all-zone calls to be made (referred to as "general urgency all-call" in this manual).

The SX-2000AO is equipped with 2 power inputs, allowing the connection of a backup power supply for use during power failures. Level meters provided for each output channel allow monitoring of audio output levels. Output volumes can be adjusted using the output volume controls on the front panel, however the maximum volume when the volume control knob is rotated fully clockwise is a default value defined by the SX-2000 Setting Software.

Also, any output channel can be monitored using the internal speaker. The key lock function, designed to prevent accidental mistaken operation, can disable output volume control and channel key settings.

*¹ The SX-2000AO has a 24 V emergency cutoff input terminal on the rear panel, allowing control of an emergency audio input. When the SX-2000 system is combined with an emergency broadcast system, a 24 V DC is normally kept being supplied to this emergency cutoff input terminal and is cut off (24 V emergency cutoff function) in emergency situations. This interrupts the general-purpose broadcast from the SX-2000 system, allowing the emergency broadcast system to override it. (For details, see the separate Installation Manual, "Installation.")

*² 1U size = 44.5 mm (standard size)

1. NOMENCLATURE AND FUNCTIONS

[Front]

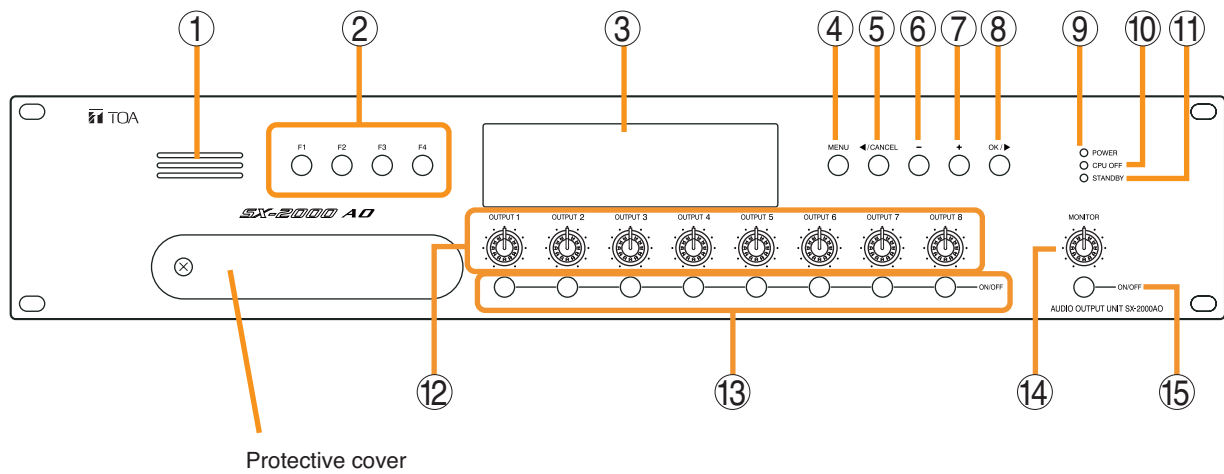

Inside of the protective cover

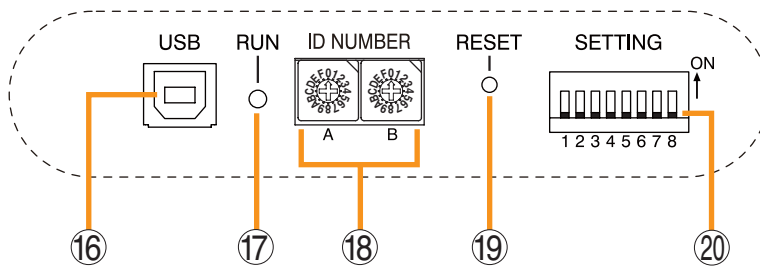

1. Monitor Speaker

Allows any output channel to be monitored.

2. Function Keys [F1, F2, F3, F4]

Pressing a function key executes the function that has been assigned to that key using the SX-2000 Setting Software.
(See the separate Setting Software Instructions, "Event Settings.")

3. Fluorescent Display

The default display shows device numbers and firmware versions.

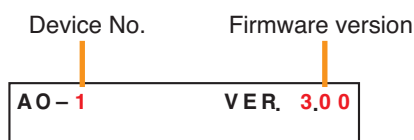

Displays the SX-2000AO's current operation status, output level, etc. (See [p. 4-4.](#))

4. Menu Key [MENU]

Pressing this key displays the fluorescent display's menu screen. Whenever this key is pressed, the screen returns to the default display for whatever portion of the menu screen is displayed.

5. Cancel Key [◀/CANCEL]

Used to switch the menu screen.

6. Minus Key [-]

Used to switch the menu screen. When the Monitor ON/OFF Key (15) is set to ON, use this key to select which channel to monitor. The selected channel number decreases by one each time this key is pressed.

7. Plus Key [+]

Used to switch the menu screen. When the Monitor ON/OFF Key (15) is set to ON, use this key to select which channel to monitor. The selected channel number increases by one each time this key is pressed.

8. OK Key [OK/▶]

Used to switch the menu screen.

9. Power Indicator [POWER] (Blue)

Lights when the power is switched on.

10. CPU OFF Indicator [CPU OFF] (Red)

Lights while the general urgency all-call (CPU OFF state) is being made ([p. 10-9](#)).

11. Standby Indicator [STANDBY] (Green)

Lights while the unit is being initialized at power-on or at reset.

Flashes when the fluorescent display is in light shutoff mode and the light stays unlit.

Lights when the SX-2000 system is operating on the backup power supply during power failures.

12. Output Volume Controls [OUTPUT 1 – 8]

Adjust the output volume of each output channel. Rotating the control fully counterclockwise mutes the output volume and causes the output ON/OFF indicator (28) on the fluorescent display to turn off.

Signals on the output channel being used for emergency broadcast are made to bypass this Output volume control.

13. Channel Keys [ON/OFF]

Turn each output channel on or off. The output channel alternates between on and off each time this key is pressed.

Other functions can also be assigned to each key by using the SX-2000 Setting Software. (See the separate Setting Software Instructions, "Event Settings.")

Signals on the output channel being used for emergency broadcast are made to bypass this Channel key.

14. Monitor Volume Control [MONITOR]

Adjusts the sound volume of the monitor speaker (1).

15. Monitor ON/OFF Key [ON/OFF]

Enables or disables the audio monitor function for the selected output channel. The monitor function alternates between on and off each time this key is pressed.

16. USB Port [USB]

This port is not used.

17. RUN Indicator [RUN] (Green)

Normally flashes continuously.

18. ID Switch [ID NUMBER]

Sets the SX-2000AO's device number. (See the separate Installation Manual, "Installation.")

19. Reset Key [RESET]

Pressing this key resets the SX-2000AO.

Notes

- Resetting the SX-2000AO stops broadcasts currently in progress via the reset SX-2000AO.
- Do not keep pressing the key for over 1 second. The unit cannot operate. If the unit operation is suspended, press the Reset key for less than one second again.

20. DIP Switch [SETTING]

• **Switch 1**

Performs key lock function settings. (See p. 4-6.)

ON: Disables operation of the front panel output volume controls and channel keys.

OFF: Cancels key lock status.

• **Switches 2 – 7**

These switches are not used.

• **Switch 8**

Enables or disables the 24 V emergency cutoff input on the rear panel. (See the separate Installation Manual, "Installation.")

Note

Switches 1 – 8 are set to the OFF position by default.

[Fluorescent Display]

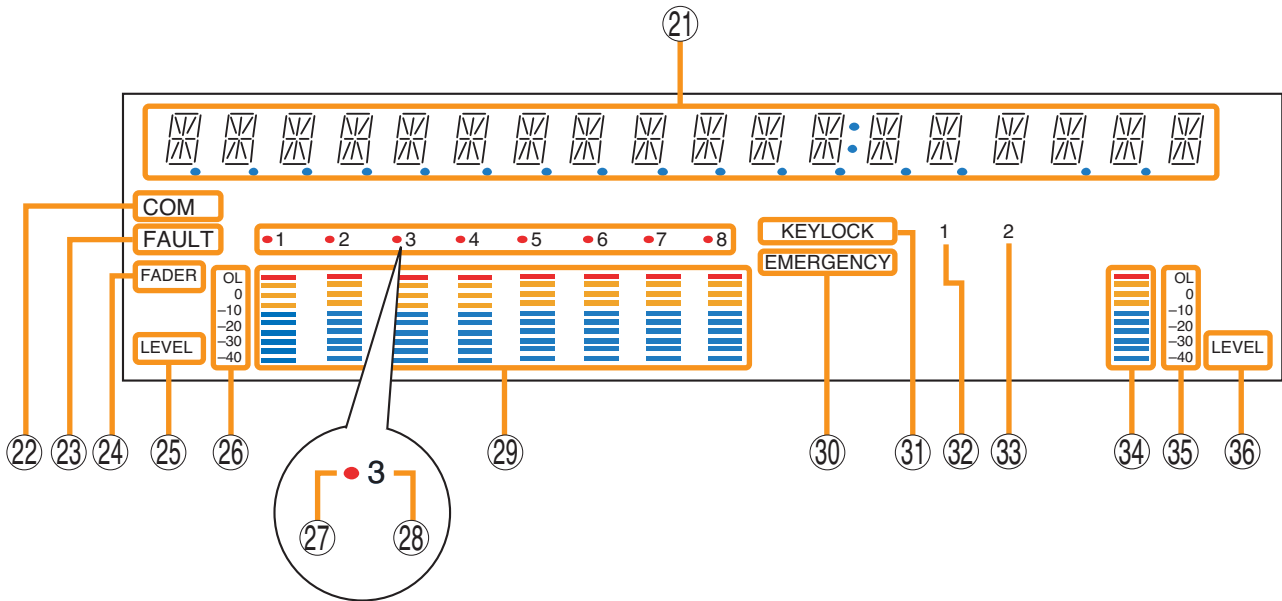

Notes

- A timer-activated light shutoff function can be set for the fluorescent display using the SX-2000 Setting Software. (See the separate Setting Software Instructions, "Basic Settings.") When the light shutoff function has been set, if the SX-2000AO is not operated for 5 minutes or more, the fluorescent display's light goes off and the standby indicator (11) begins to flash. Pressing any keys other than the function keys on the front panel resets the screen display.
- Normally, the fluorescent display's light goes off at the time of the power failure.
- While the SX-2000 system is in an emergency condition, the fluorescent display's light does not go off even if the power fails.

21. Text Display Area

Displays the menu screen information when the corresponding function key is pressed.

22. COM Indicator [COM]

Flashes to indicate a communications error.

23. Fault Indicator [FAULT]

Flashes when a system failure, incorrect system configuration*¹ or communications error is detected. This indicator continues to flash until failure conditions return to normal.

*¹ When the system or module configuration differs from the contents set by the SX-2000 Setting Software.

24. Output Level Meter Fader Indicator [FADER]

Lights when the output level meter indicates the sound volume set using the SX-2000 Setting Software or output volume control.

25. Output Level Meter Level Indicator [LEVEL]

Lights when the output level meter indicates the level being output from the SX-2000AO.

26. Output Level Meter Scale

27. Output Indicator

The output channel to be monitored lights red.

28. Output ON/OFF Indicator

Indicates the unit's operating status when the corresponding channel key is pressed. The indicator state differs depending on the function assigned to each channel key as follows.

Function assigned to the channel key	When ON	When OFF
Output ON/OFF	Lights*	Unlit
General-purpose pattern broadcast's activation and termination	Flashes	Lights

* The indicator state is "Unlit" when the output volume is muted.

29. Output Level Meter

Indicates the actual level or a set volume value on each output channel.

30. Emergency Indicator [EMERGENCY]

Lights when the SX-2000 system is in an emergency condition.

When the 24 V emergency cutoff input*2 is enabled, this indicator flashes if the input receives an emergency signal.

*2 The SX-2000AO has a 24 V emergency cutoff input terminal on the rear panel, allowing control of an emergency audio input. When the SX-2000 system is combined with an emergency broadcast system, a 24 V DC is normally kept being supplied to this emergency cutoff input terminal and is cut off (24 V emergency cutoff function) in emergency situations. This interrupts the general-purpose broadcast from the SX-2000 system, allowing the emergency broadcast system to override it. (For details, see the separate Installation Manual, "Installation.")

Note

When the 24 V Emergency cutoff input is set to be disabled (not usable) with the DIP switch 8 inside the protective cover, the Emergency indicator will not flash even if 24 V DC supply to this input terminal is cut off.

31. Key Lock Indicator [KEY LOCK]

Lights when the output volume controls and channel keys are all locked. (See p. 4-6, "Key Lock Settings and Cancellation.")

32. Control Input Unit Connection Indicator [1]

Indicates "1" when the SX-2000CI is connected to the SX-2000AO.

33. Control Output Unit Connection Indicator [2]

Indicates "2" when the SX-2000CO is connected to the SX-2000AO.

34. Monitor Level Meter

Indicates the sound volume level of the output channel being monitored.

35. Monitor Level Meter Scale

Lights when the Monitor ON/OFF Key (15) is set to ON.

36. Monitor ON/OFF Indicator [LEVEL]

Lights when the Monitor ON/OFF Key (15) is set to ON.

2. KEY LOCK SETTINGS AND CANCELLATION (DIP Switch 1 Operation)

It is possible to disable the output volume controls, and channel keys in order to prevent mistaken operation. The output volume level set while the key lock function is used takes effect after the key lock has been released.

Note

When the SX-2000 system is placed in an emergency condition during key lock OFF, the output level for the emergency broadcast zone preset with the front-mounted volume control knob is invalid, but that defined by the SX-2000 Setting Software is valid.

During key lock ON, however, the volume level set with the output volume control knob is valid even if the SX-2000 system is placed in an emergency condition. Before setting key lock function to ON, be sure to adjust the output volume control knob corresponding to the emergency broadcast zone for a proper sound level.

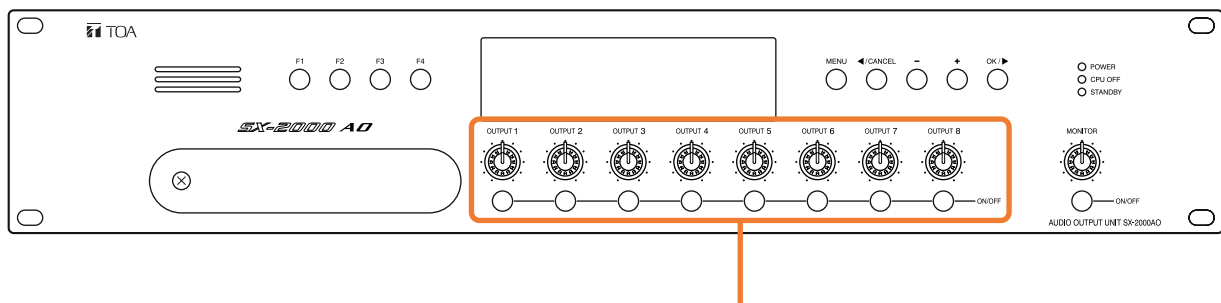

Controls and Keys that can be locked

Step 1. Remove the protective cover on the SX-2000AO's front panel by unscrewing it with a Phillips screwdriver.

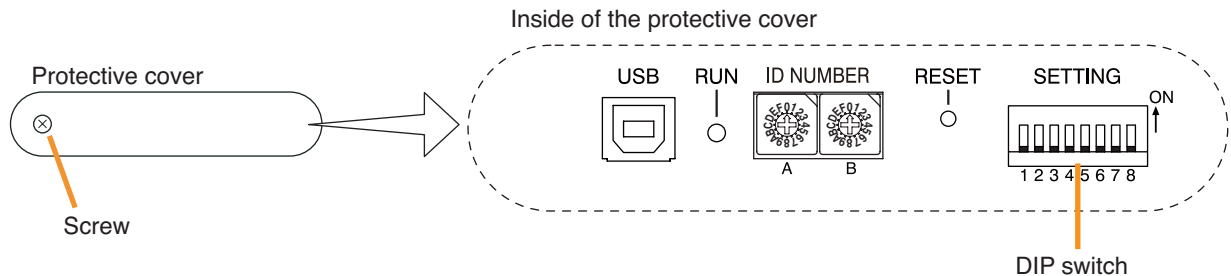

Note: DIP switch 1 is set to OFF by default.

Step 2. Set the switches.

2-1. If setting a key lock function:

Set DIP switch 1 to ON. When keys have been locked, the KEY LOCK indicator in the fluorescent display lights.

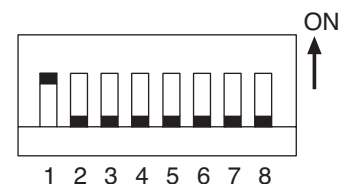

2-2. If canceling a key lock function:

Set DIP switch 1 to OFF. When key locking has been cancelled, the KEY LOCK indicator in the fluorescent display goes off.

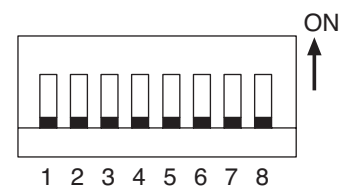

Step 3. Replace the protective cover.

3. OPERATING THE MENU SCREEN

Setting values can be confirmed or changed from the SX-2000AO's front panel.

3.1. Menu Screen Operation Keys

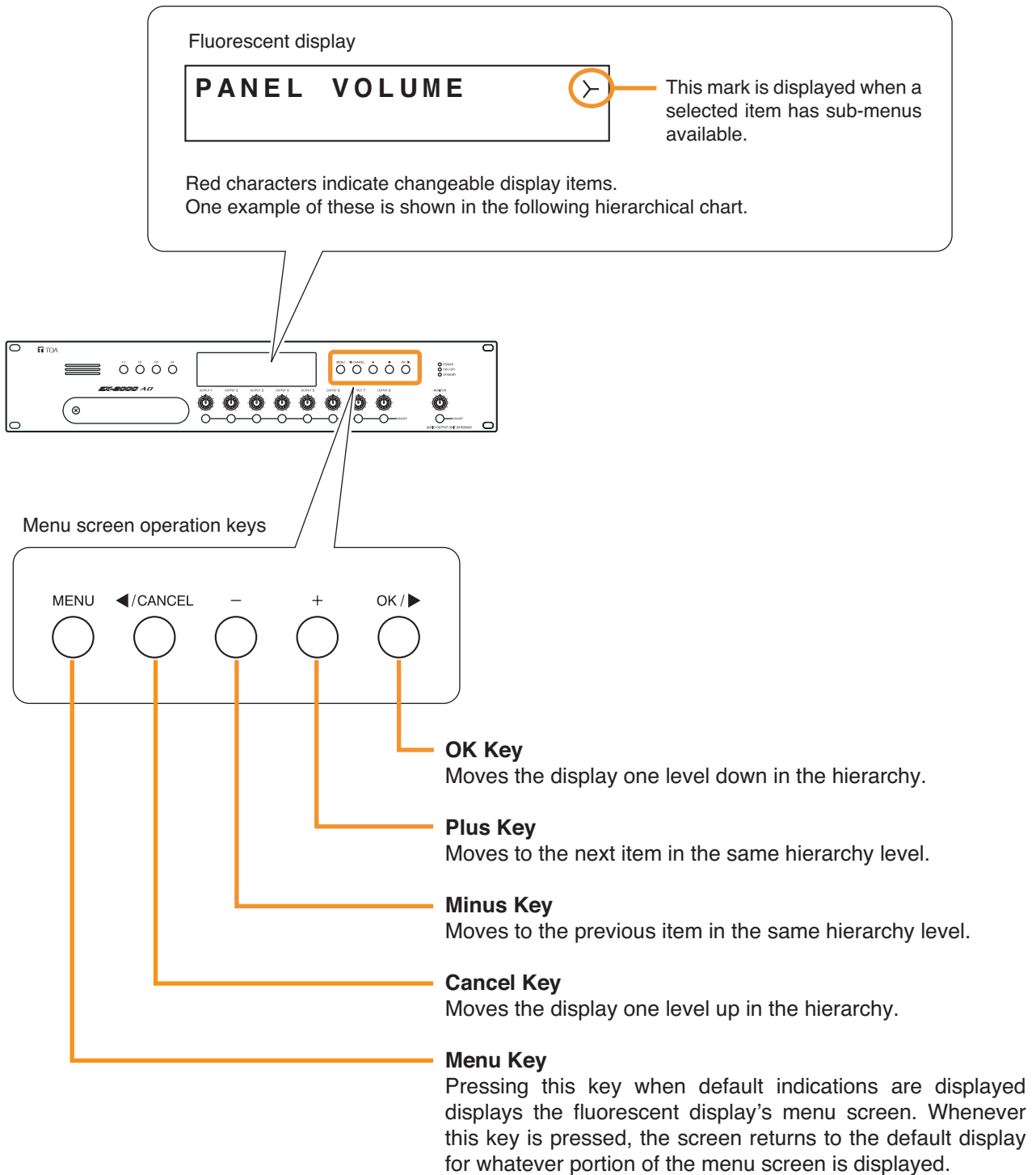

3.2. Menu Screen Hierarchical Chart

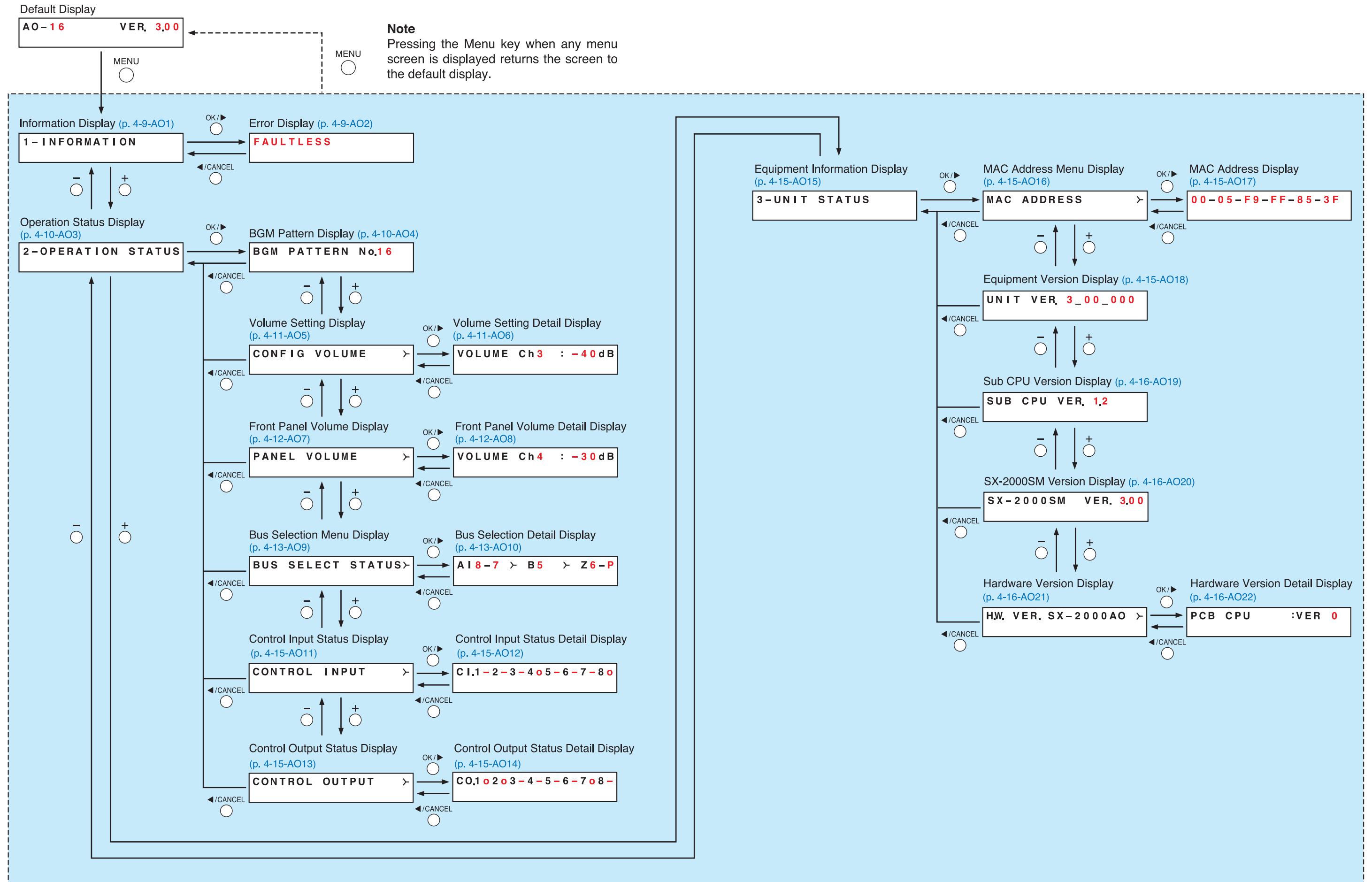

3.3. Explanations of Menu Screen Items

3.3.1. Information Display (AO1)

1 – I N F O R M A T I O N

Display screen for menu item "Information."

[Error Display (AO2)]

When any of the Fault indicators on the SX-2000SM's front panel is flashing, or when the Fault indicator or COM indicator on the SX-2000AO's fluorescent display is flashing, a brief error message appears in the text display area as shown below.

FAULTLESS

No abnormality or failure is detected.
(Fault and COM indicators: Off)

COMPONENT ERROR

Incorrect system configuration* is detected.
(Fault indicator: Flashing)

* When the system or module configuration differs from the contents set by the SX-2000 Setting Software.

FAULT DETECTED

System failure is detected. (e.g. The RM-200SA's microphone has failed.)
(Fault indicator: Flashing)

SX LINK COM FAULT

Communications error* is detected.
(Fault and COM indicators: Flashing)

* The SX-2000AO cannot communicate with the SX-2000SM.

Note

Contents of failure or abnormality can be confirmed by using the log data stored in the SX-2000SM.
(See [p. 1-5](#).)

3.3.2. Operation Status Display (AO3)

2 - OPERATION STATUS

Display screen for menu item "Operation Status."

[BGM Pattern Display (AO4)]

BGM PATTERN No.1 6

Displays the pattern number for a BGM broadcast in progress.

When this screen is displayed, the Output ON/OFF indicator on the fluorescent display is as follows:

Indicates the unit's operating status when the corresponding function keys (F1 to F4) are pressed.
The indicator state differs depending on the function assigned to each function key as follows.

Function assigned to the function key	Display
Change or end the BGM pattern	Unlit: When the BGM pattern assigned to the function key is not being broadcast Lights: When the BGM pattern assigned to the function key is being broadcast
General-purpose broadcast pattern	Unlit: When the function key is OFF Flashes: When the function key is ON

The diagram shows a control panel with 16 indicator lights in a row. Below them are 8 faders, each with a red dot and a label (1-8). The first four faders (1-4) are highlighted with an orange box and a callout circle containing the number '1'. To the right of the faders are indicators for KEYLOCK (1, 2), EMERGENCY, and LEVEL (OL, 0, -10, -20, -30, -40).

[Volume Setting Display (AO5), Volume Setting Detail Display (AO6)]

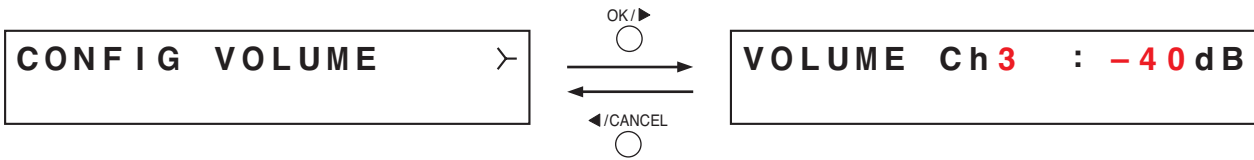

Indicates the output volume level set using the SX-2000 Setting Software in the output level meter. Besides, on the Volume Setting Detail Display screen, the set value for each output channel can be confirmed numerically.

Pressing the plus key increases the channel number by one and displays the setting value for that channel. Pressing the minus key decreases the channel number by one and displays the setting value for that channel.

When these screens are displayed, the entire fluorescent display is as follows:

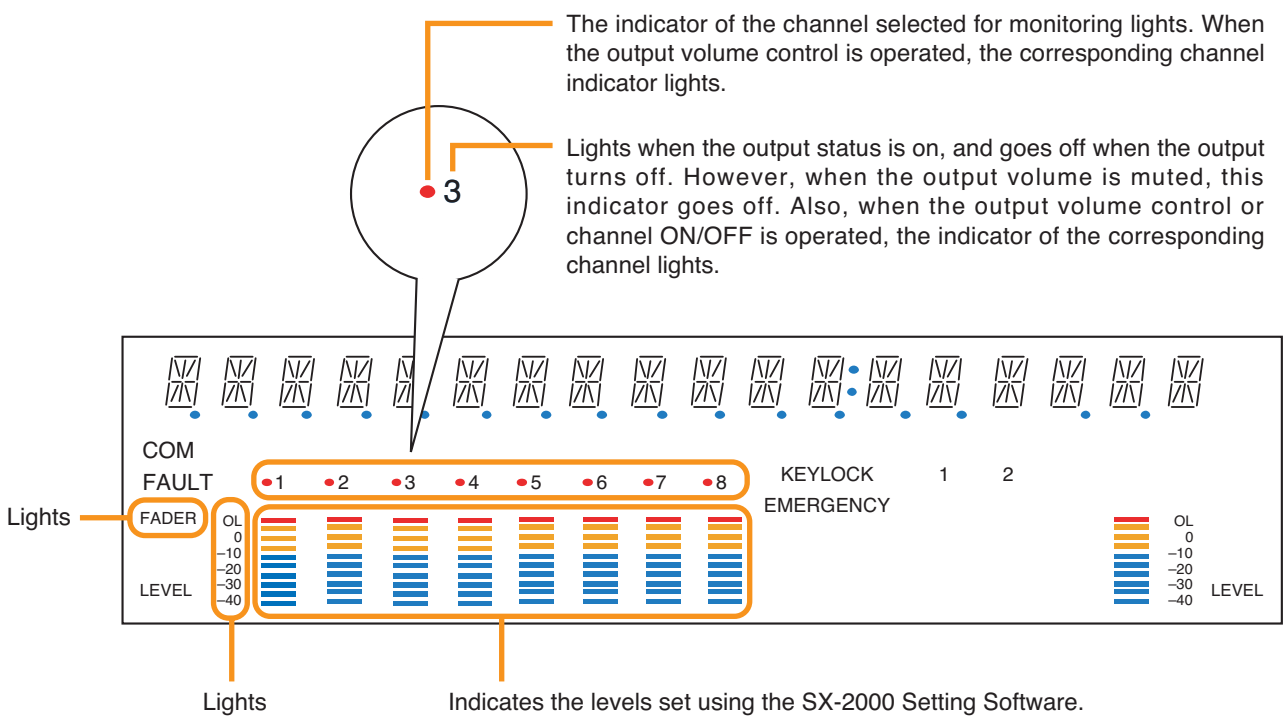

[Front Panel Volume Display (AO7), Front Panel Volume Detail Display (AO8)]

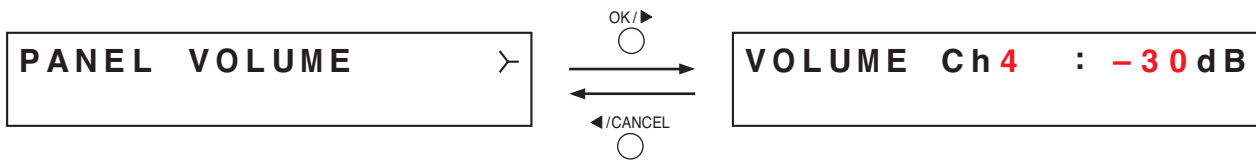

Indicates the output volume level set using the front panel's output volume control in the output level meter. Besides, on the Front Panel Volume Detail Display screen, the set value for each output channel can be confirmed numerically.

Pressing the plus key increases the channel number by one and displays the setting value for that channel. Pressing the minus key decreases the channel number by one and displays the setting value for that channel.

When these screens are displayed, the entire fluorescent display is as follows:

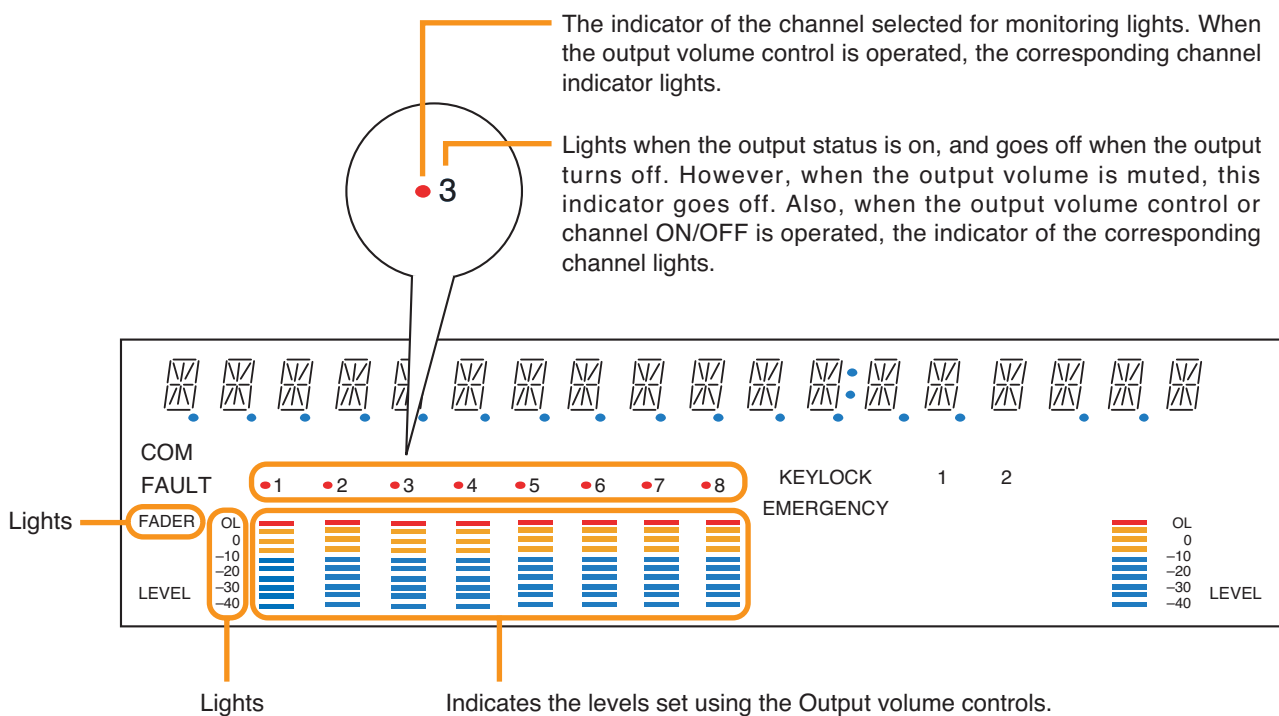

[Bus Selection Menu Display (AO9), Bus Selection Detail Display (AO10)]

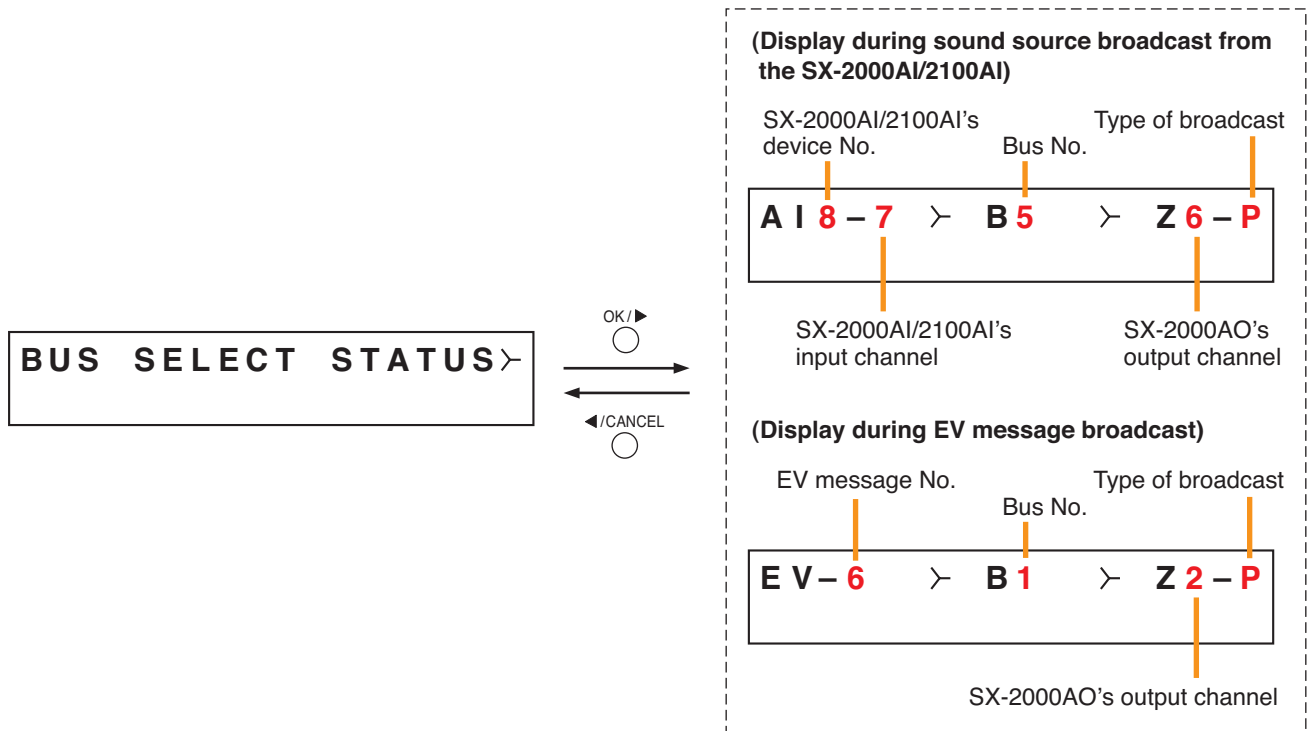

A "bus" is a path through which audio signals pass. The SX-2000 system has 16 bus lines. The Bus Selection Detail Display shows which input sound source is being sent to the SX-2000AO's output channel through which bus.

Pressing the plus key increases the output channel number by one and displays the broadcast status for that channel.

Pressing the minus key decreases the output channel number by one and displays the broadcast status for that channel.

Regarding the type of broadcast, "B" is displayed for BGM broadcasts, and "P" is displayed for general-purpose broadcasts or emergency broadcasts. This broadcast type indication alternates between "B" and "P" each time the OK key is pressed. For output channels not making broadcasts, the indication "--" is displayed for the SX-2000AI's and SX-2100AI's device No., for the SX-2000AI's and SX-2100AI's input channel, and for the bus No.

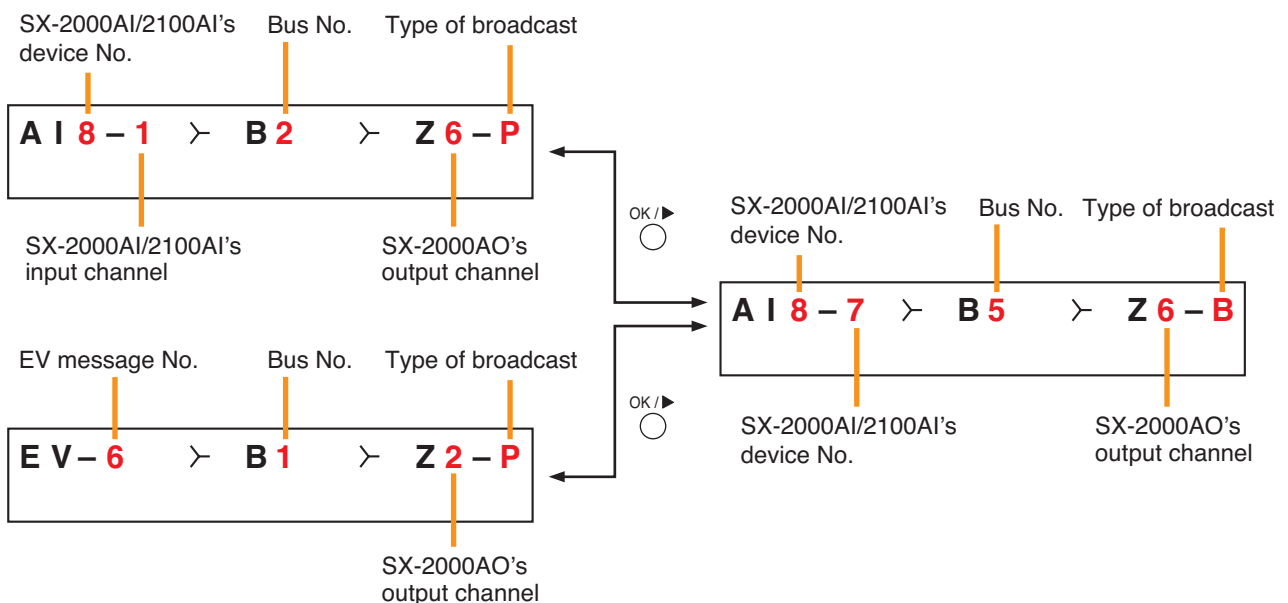

Note

BGM broadcasts cannot be made to the zones where an emergency broadcast is in progress. So, the indication "--" is displayed on the "BGM" Bus Display screen as shown at right while an emergency broadcast is being made.

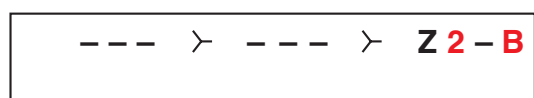

When these screens are displayed, the entire fluorescent display is as follows:

The indicator of the channel selected for monitoring lights.
When the output volume control is operated, the corresponding channel indicator lights.

Indicates the unit's operating status when the corresponding channel key is pressed.
The indicator state differs depending on the function assigned to each channel key as follows.

Function assigned to the channel key	Display
Output ON/OFF	Unlit: When the output channel is OFF Lights: When the output channel is ON (The indicator state is "Unlit" when the output volume is muted.) When operating the corresponding output volume control or channel key
General-purpose broadcast pattern	Lights: When the channel key is OFF Flashes: When the channel key is ON

These indicators light when the Monitor ON/OFF key is set to ON.

COM
FAULT
FADER
LEVEL

1 2 3 4 5 6 7 8

KEYLOCK
EMERGENCY

1 2

OL
0
-10
-20
-30
-40

LEVEL

Lights

Indicates the level being output from the SX-2000AO.

When the Monitor ON/OFF key is set to ON, this meter shows the signal level of the output channel being monitored.

[Control Input Status Display (AO11), Control Input Status Detail Display (AO12)]

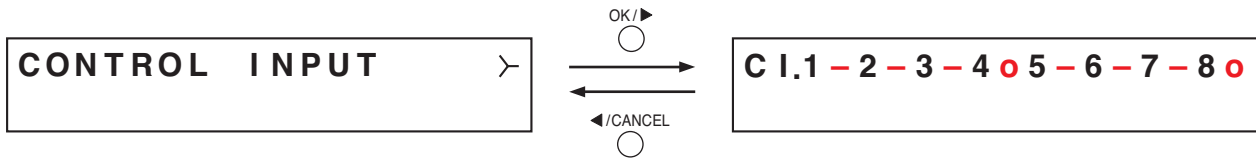

Displays the current control input status.
 "o" is displayed when the control input is on, and "-" is displayed when the control input is off.

[Control Output Status Display (AO13), Control Output Status Detail Display (AO14)]

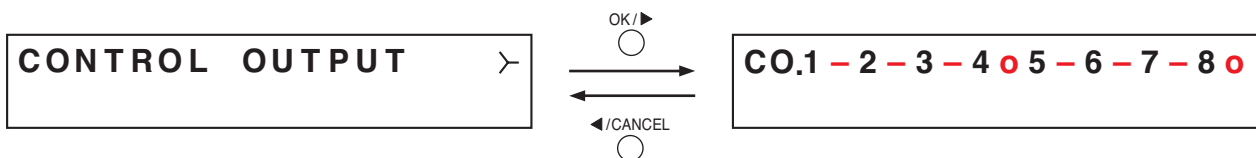

Displays the current control output status.
 "o" is displayed when the control output is on, and "-" is displayed when the control output is off.

3.3.3. Equipment Information Display (AO15)



Display screen for menu item "Equipment Information."

[MAC Address Menu Display (AO16), MAC Address Display (AO17)]

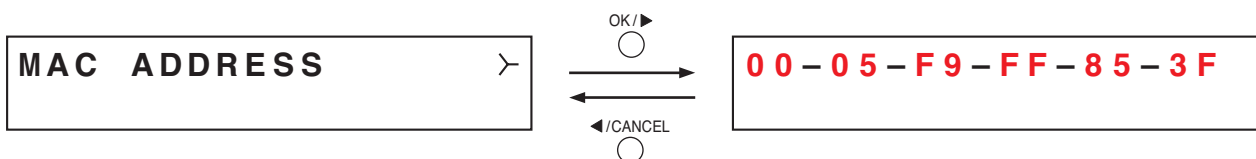

Displays the MAC address* set to the SX-2000AO on the Mac Address Display screen.

* A 12-digit hexadecimal address inherently assigned to and unique to a networking device.

[Equipment Version Display (AO18)]



Displays the SX-2000AO's firmware version.

[Sub CPU Version Display (AO19)]



Displays the version of software related to operations and displays on the SX-2000AO's front panel.

[SX-2000SM Version Display (AO20)]



Displays SX-2000SM firmware version.

It appears when the communication with the SX-2000SM is complete. Before that, "Ver.-- --" is displayed on the version display section.

[Hardware Version Display (AO21), Hardware Version Detail Display (AO22)]

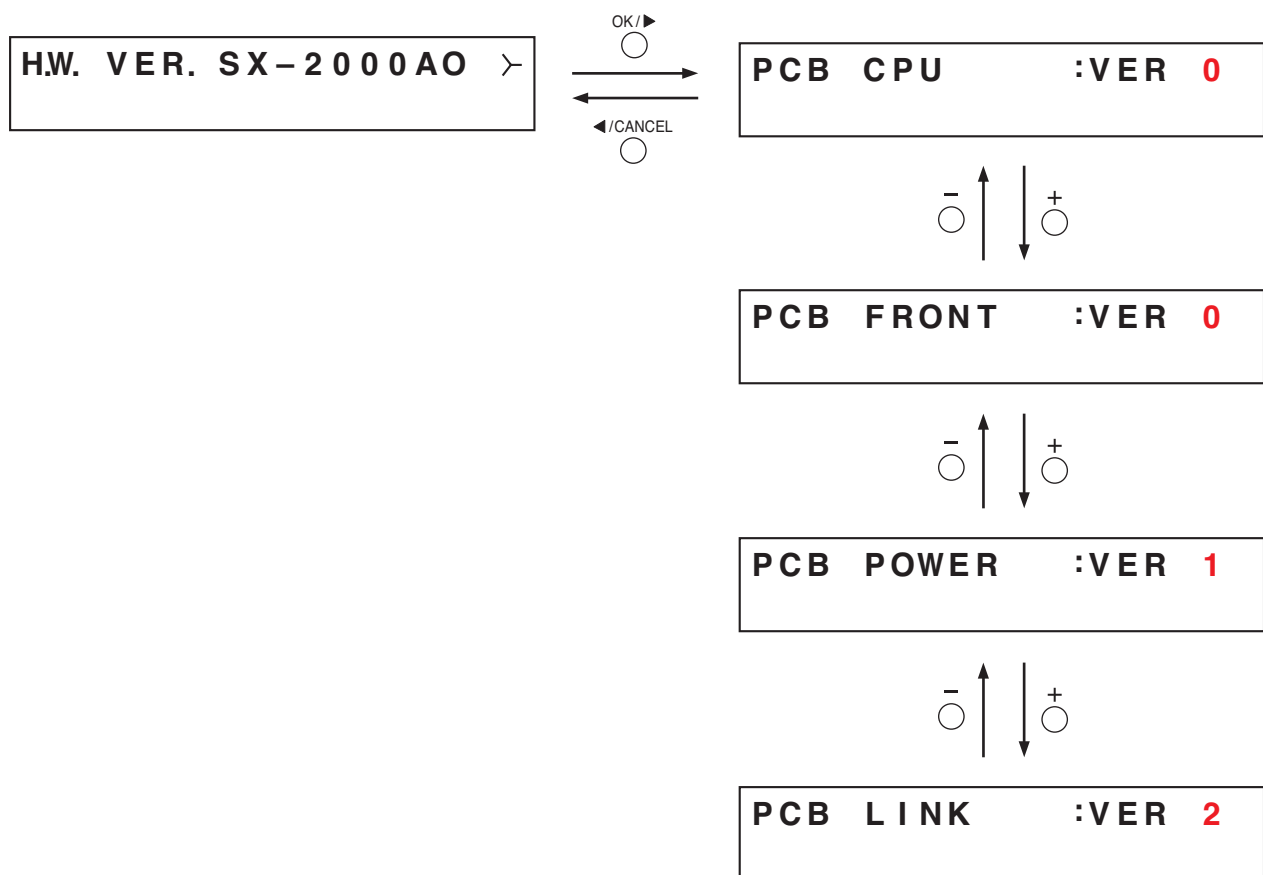

Displays the hardware version for each circuit board comprising the SX-2000AO unit.

In the screens of Hardware Version Detail Display, pressing the plus or minus key advances or reverses the screen.

- PCB CPU: Displays the CPU circuit board version.
- PCB FRONT: Displays the front circuit board version.
- PCB POWER: Displays the power supply circuit board version.
- PCB LINK: Displays the link circuit board version.

Chapter 5

SX-2100AO AUDIO OUTPUT UNIT

The SX-2100AO is an audio output unit for use with the SX-2000 system. It is equipped with 8 audio outputs, 8 control inputs, and 8 control outputs. In addition, one each of the SX-2000CI Control Input Unit and SX-2000CO Control Output Unit can be cascade-connected to the SX-2100AO, allowing the number of SX-2000 system's control inputs and outputs to be increased.

Two local audio inputs with control inputs are provided for the SX-2100AO's audio inputs.

Its main functions include an amplifier switching function that automatically switches the power amplifier to the standby amplifier if the power amplifier fails, and a surveillance function that self-diagnoses the speaker lines.

It is equipped with 2 channels of link connection terminals for connecting to two VX-2000DS Emergency Power Supply units, allowing the backup power supply (one of the two) to be activated when the main power supply fails, thus preventing system down.

It can be mounted in an EIA equipment rack (2U size*), and multiple units can be installed in different locations with no need to centralize in one location.

Two inputs can be mixed and output. The SX-2100AO receives audio signals from the SX-2000AI or SX-2100AI Audio Input Unit by means of digital transmission in normal operating condition. However, if no general broadcasts can be made due to system failures, the SX-2100AO uses an analog transmission path to receive audio signals, enabling all-zone calls to be made (referred to as "general urgency all-call" in this manual).

The SX-2100AO is equipped with 2 power inputs, allowing the connection of a backup power supply for use during power failures. Level meters provided for each output channel allow monitoring of audio output levels. Output volumes can be adjusted using the output volume controls on the front panel, however the maximum volume when the volume control knob is rotated fully clockwise is a default value defined by the SX-2000 Setting Software.

Also, any output channel can be monitored using the internal speaker. The key lock function, designed to prevent accidental mistaken operation, can disable output volume control and channel key settings.

* 1U size = 44.5 mm (standard size)

1. NOMENCLATURE AND FUNCTIONS

[Front]

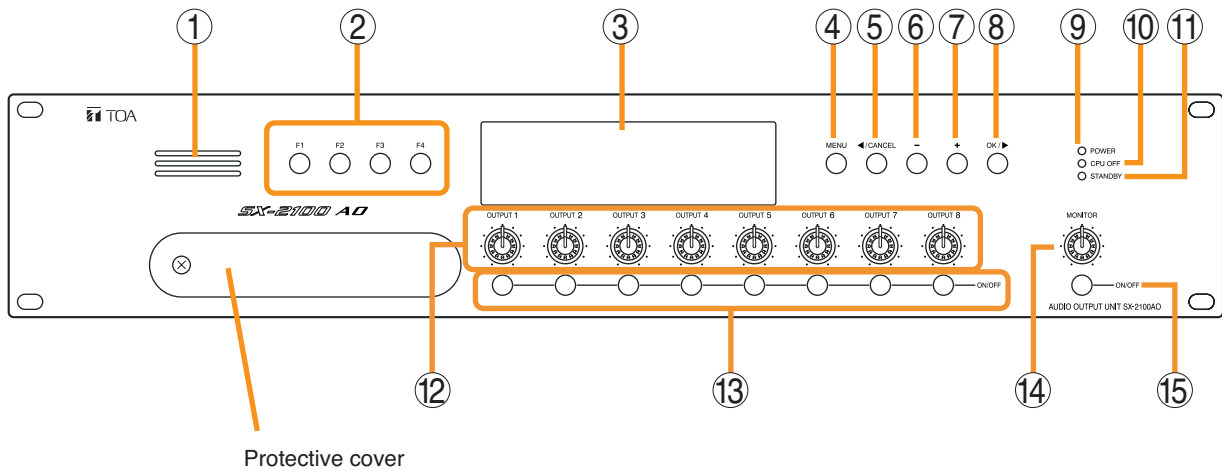

Inside of the protective cover

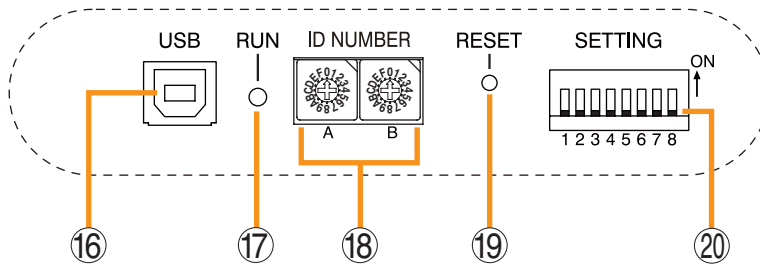

1. Monitor Speaker

Allows any output channel to be monitored.

2. Function Keys [F1, F2, F3, F4]

Pressing a function key executes the function that has been assigned to that key using the SX-2000 Setting Software. (See the separate Setting Software Instructions, "Event Settings.")

3. Fluorescent Display

The default display shows device numbers and firmware versions.

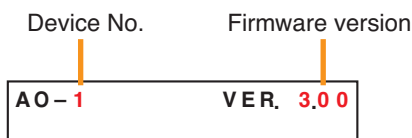

Displays the SX-2100AO's current operation status, output level, etc. (See p. 5-4.)

4. Menu Key [MENU]

Pressing this key displays the fluorescent display's menu screen. Whenever this key is pressed, the screen returns to the default display for whatever portion of the menu screen is displayed.

5. Cancel Key [◀ /CANCEL]

Used to switch the menu screen.

6. Minus Key [-]

Used to switch the menu screen. When the Monitor ON/OFF Key (15) is set to ON, use this key to select which channel to monitor. The selected channel number decreases by one each time this key is pressed.

7. Plus Key [+]

Used to switch the menu screen. When the Monitor ON/OFF Key (15) is set to ON, use this key to select which channel to monitor. The selected channel number increases by one each time this key is pressed.

8. OK Key [OK/▶]

Used to switch the menu screen.

9. Power Indicator [POWER] (Blue)

Lights when the power is switched on.

10. CPU OFF Indicator [CPU OFF] (Red)

Lights while the general urgency all-call (CPU OFF state) is being made (p. 10-9).

11. Standby Indicator [STANDBY] (Green)

Lights while the unit is being initialized at power-on or at reset.

Flashes when the fluorescent display is in light shutoff mode and the light stays unlit.

Lights when the SX-2000 system is operating on the backup power supply during power failures.

12. Output Volume Controls [OUTPUT 1 – 8]

Adjust the output volume of each output channel. Rotating the control fully counterclockwise mutes the output volume and causes the output ON/OFF indicator (28) on the fluorescent display to turn off.

Signals on the output channel being used for emergency broadcast are made to bypass this Output volume control.

13. Channel Keys [ON/OFF]

Turn each output channel on or off. The output channel alternates between on and off each time this key is pressed.

Other functions can also be assigned to each key by using the SX-2000 Setting Software. (See the separate Setting Software Instructions, "Event Settings.")

Signals on the output channel being used for emergency broadcast are made to bypass this Channel key.

14. Monitor Volume Control [MONITOR]

Adjusts the sound volume of the monitor speaker (1).

15. Monitor ON/OFF Key [ON/OFF]

Enables or disables the audio monitor function for the selected output channel. The monitor function alternates between on and off each time this key is pressed.

16. USB Port [USB]

This port is not used.

17. RUN Indicator [RUN] (Green)

Normally flashes continuously.

18. ID Switch [ID NUMBER]

Sets the SX-2100AO's device number. (See the separate Installation Manual, "Installation.")

19. Reset Key [RESET]

Pressing this key resets the SX-2100AO.

Notes

- Resetting the SX-2100AO stops broadcasts currently in progress via the reset SX-2100AO.
- Do not keep pressing the key for over 1 second. The unit cannot operate. If the unit operation is suspended, press the Reset key for less than one second again.

20. DIP Switch [SETTING]

• **Switch 1**

Performs key lock function settings. (See p. 5-6.)
 ON: Disables operation of the front panel output volume controls and channel keys.
 OFF: Cancels key lock status.

• **Switches 2 – 7**

These switches are not used.

• **Switch 8**

Use this switch to perform the speaker line initial setting.
 (For details, see the separate Installation Manual, "Speaker Line Initial Setting.")

Note

Switches 1 – 8 are set to the OFF position by default.

[Fluorescent Display]

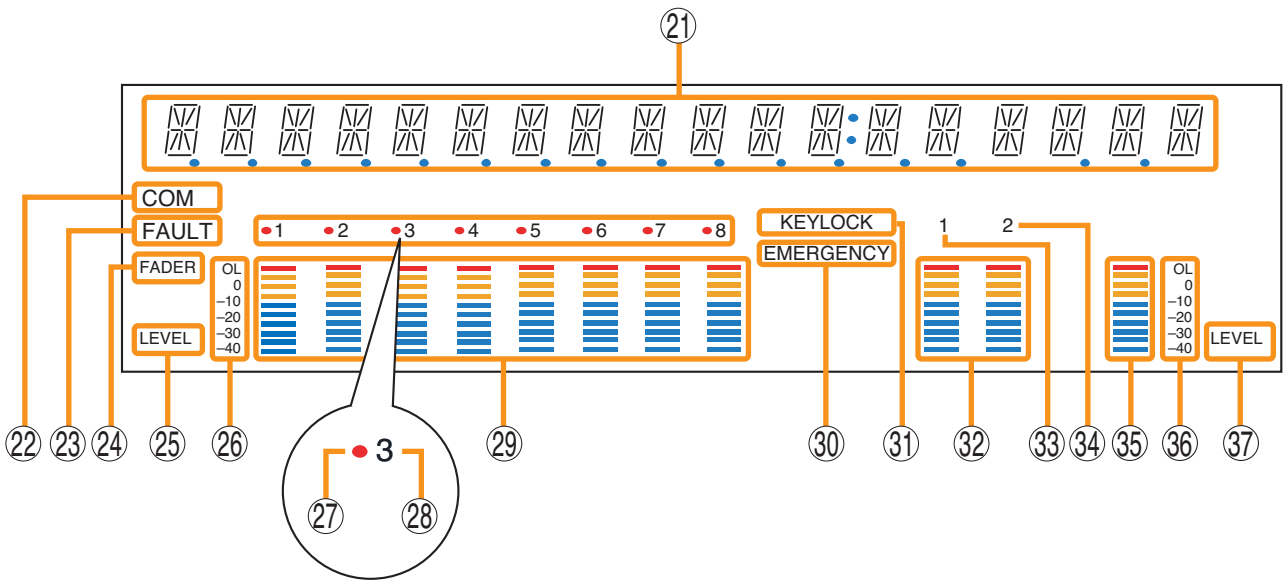

Notes

- A timer-activated light shutoff function can be set for the fluorescent display using the SX-2000 Setting Software. (See the separate Setting Software Instructions, "Basic Settings.")
When the light shutoff function has been set, if the SX-2100AO is not operated for 5 minutes or more, the fluorescent display's light goes off and the standby indicator (11) begins to flash. Pressing any keys other than the function keys on the front panel resets the screen display.
- Normally, the fluorescent display's light goes off at the time of the power failure.
- While the SX-2000 system is in an emergency condition, the fluorescent display's light does not go off even if the power fails.

21. Text Display Area

Displays the menu screen information when the corresponding function key is pressed.

22. COM Indicator [COM]

Flashes to indicate a communications error.

23. Fault Indicator [FAULT]

Flashes when a system failure, incorrect system configuration*¹ or communications error is detected. This indicator continues to flash until failure conditions return to normal.

*¹ When the system or module configuration differs from the contents set by the SX-2000 Setting Software.

24. Output Level Meter Fader Indicator [FADER]

Lights when the output level meter indicates the sound volume set using the SX-2000 Setting Software or output volume control.

25. Output Level Meter Level Indicator [LEVEL]

Lights when the output level meter indicates the level being output from the SX-2100AO.

26. Output Level Meter Scale

27. Output Indicator

The output channel to be monitored lights red.

28. Output ON/OFF Indicator

Indicates the unit's operating status when the corresponding channel key is pressed.

The indicator state differs depending on the function assigned to each channel key as follows.

Function assigned to the channel key	When ON	When OFF
Output ON/OFF	Lights*	Unlit
General-purpose pattern broadcast	Flashes	Lights

* The indicator state is "Unlit" when the output volume is muted.

29. Output Level Meter

Indicates the actual level or a set volume value on each output channel.

30. Emergency Indicator [EMERGENCY]

Lights when the SX-2000 system is in an emergency condition.

31. Key Lock Indicator [KEY LOCK]

Lights when the output volume controls and channel keys are all locked. (See p. 5-6 "Key Lock Settings and Cancellation.")

32. Local Audio Input Level Meter

Indicates each level of signals applied to the Local audio inputs 1 and 2 while the Local audio control inputs 1 and 2 are activated, respectively.

33. Control Input Unit Connection Indicator [1]

Indicates "1" when the SX-2000CI is connected to the SX-2100AO.

34. Control Output Unit Connection Indicator [2]

Indicates "2" when the SX-2000CO is connected to the SX-2100AO.

35. Monitor Level Meter

Indicates the sound volume level of the output channel being monitored.

36. Monitor Level Meter Scale

Lights when the Monitor ON/OFF Key (15) is set to ON.

37. Monitor ON/OFF Indicator [LEVEL]

Lights when the Monitor ON/OFF Key (15) is set to ON.

2. KEY LOCK SETTINGS AND CANCELLATION (DIP Switch 1 Operation)

It is possible to disable the output volume controls and channel keys in order to prevent mistaken operation. The output volume level set while the key lock function is used takes effect after the key lock has been released.

Note

When the SX-2000 system is placed in an emergency condition during key lock OFF, the output level for the emergency broadcast zone preset with the front-mounted volume control knob is invalid, but that defined by the SX-2000 Setting Software is valid.

During key lock ON, however, the volume level set with the output volume control knob is valid even if the SX-2000 system is placed in an emergency condition. Before setting key lock function to ON, be sure to adjust the output volume control knob corresponding to the emergency broadcast zone for a proper sound level.

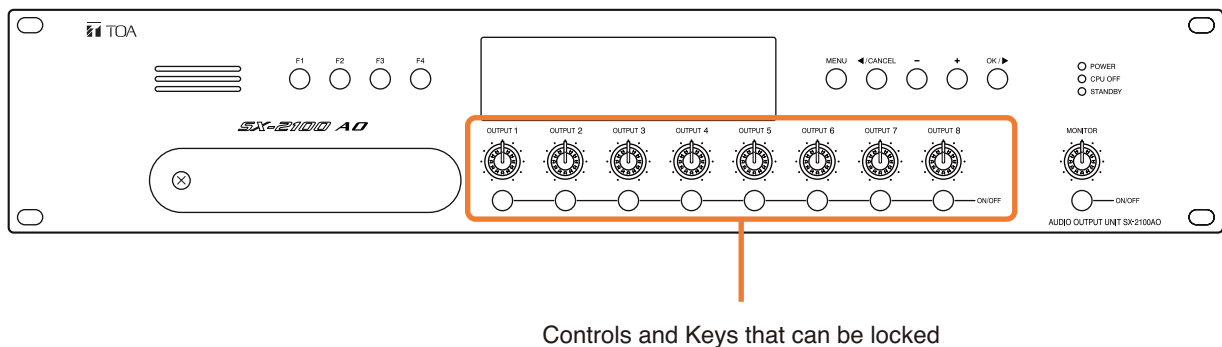

Step 1. Remove the protective cover on the SX-2100AO's front panel by unscrewing it with a Phillips screwdriver.

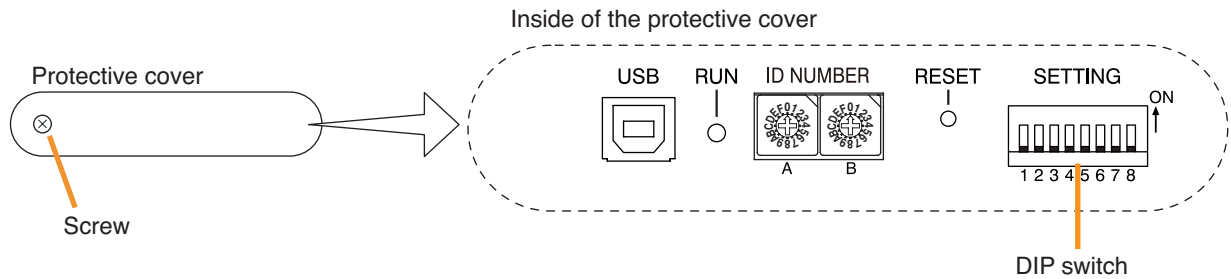

Note: DIP switch 1 is set to OFF by default.

Step 2. Set the switches.

2-1. If setting a key lock function:

Set DIP switch 1 to ON. When keys have been locked, the KEY LOCK indicator in the fluorescent display lights.

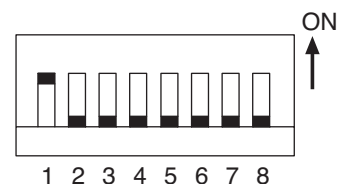

2-2. If canceling a key lock function:

Set DIP switch 1 to OFF. When key locking has been cancelled, the KEY LOCK indicator in the fluorescent display goes off.

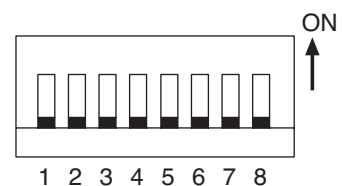

Step 3. Replace the protective cover.

3. OPERATING THE MENU SCREEN

Setting values can be confirmed or changed from the SX-2100AO's front panel.

3.1. Menu Screen Operation Keys

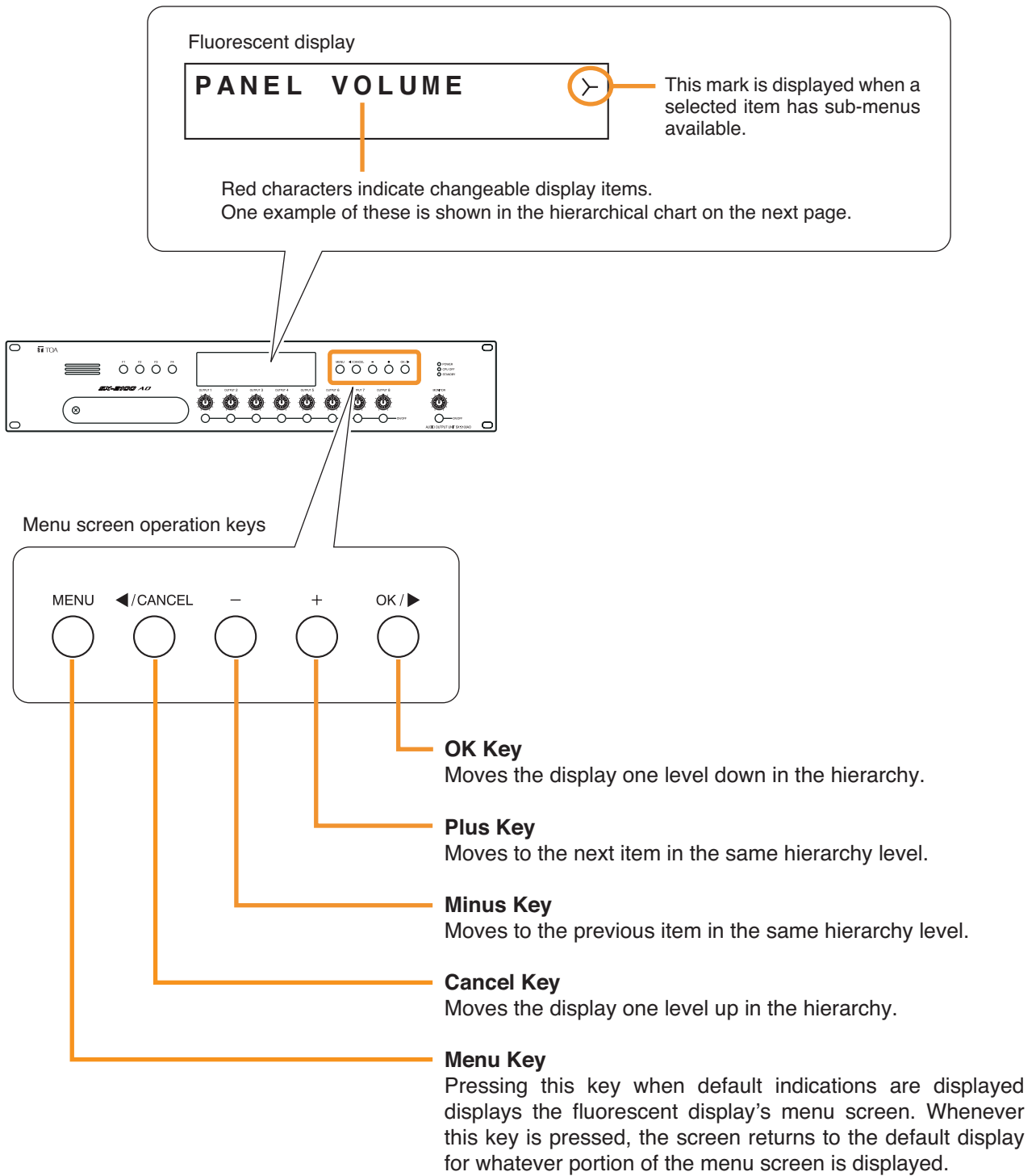

3.2. Menu Screen Hierarchical Chart

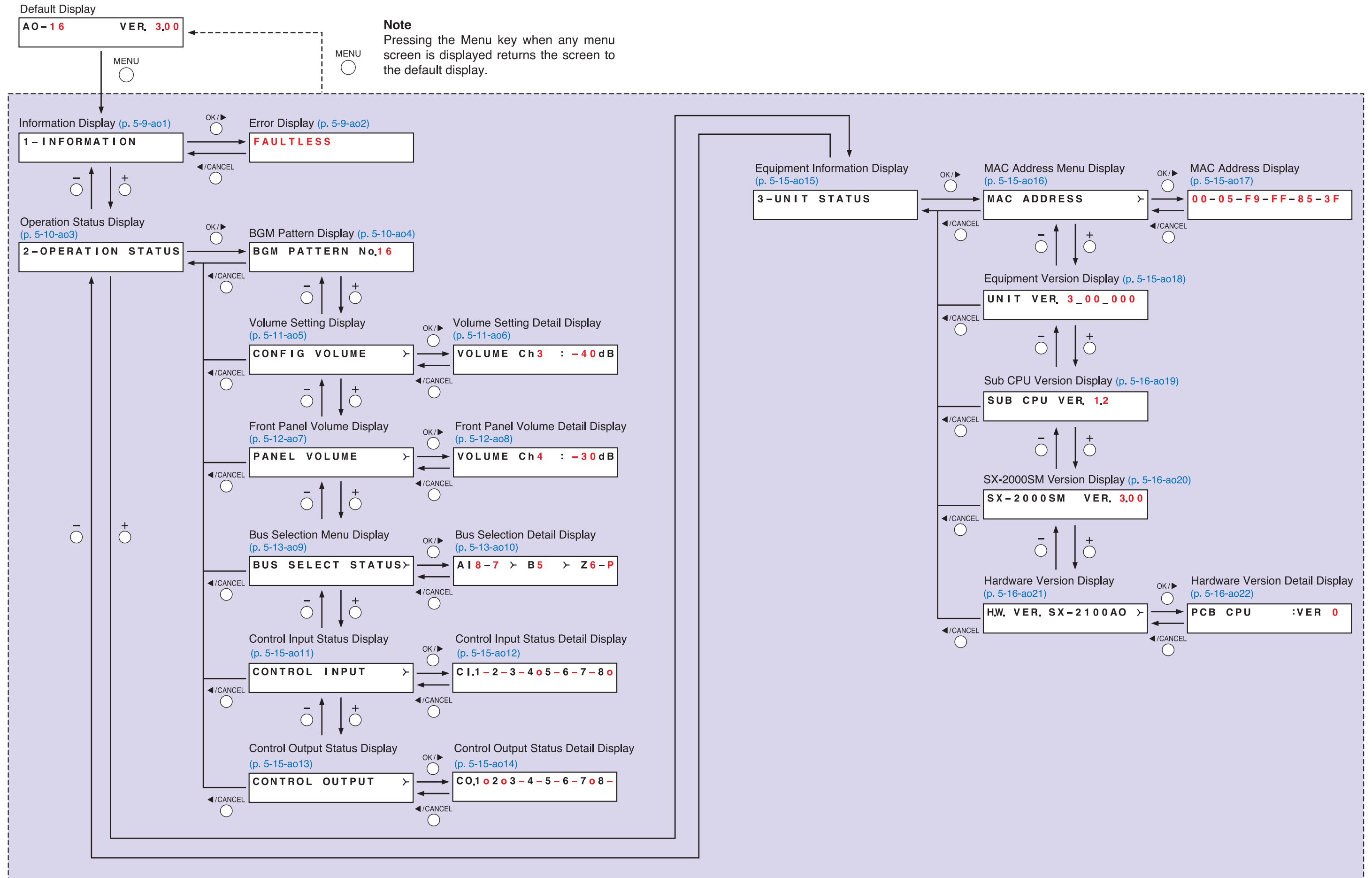

3.3. Explanations of Menu Screen Items

3.3.1. Information Display (ao1)

1 – I N F O R M A T I O N

Display screen for menu item "Information."

[Error Display (ao2)]

When any of the Fault indicators on the SX-2000SM's front panel is flashing, or when the Fault indicator or COM indicator on the SX-2100AO's fluorescent display is flashing, a brief error message appears in the text display area as shown below.

FAULTLESS

No abnormality or failure is detected.
(Fault and COM indicators: Off)

COMPONENT ERROR

Incorrect system configuration* is detected.
(Fault indicator: Flashing)

* When the system or module configuration differs from the contents set by the SX-2000 Setting Software.

FAULT DETECTED

System failure is detected. (e.g. The RM-200SA's microphone has failed.)
(Fault indicator: Flashing)

SX LINK COM FAULT

Communications error* is detected.
(Fault and COM indicators: Flashing)

* The SX-2100AO cannot communicate with the SX-2000SM.

Note

Contents of failure or abnormality can be confirmed by using the log data stored in the SX-2000SM.
(See [p. 1-5](#).)

3.3.2. Operation Status Display (ao3)

2 - OPERATION STATUS

Display screen for menu item "Operation Status."

[BGM Pattern Display (ao4)]

BGM PATTERN No.1 6

Displays the pattern number for a BGM broadcast in progress.

When this screen is displayed, the Output ON/OFF indicator on the fluorescent display is as follows:

Indicates the unit's operating status when the corresponding function keys (F1 to F4) are pressed. The indicator state differs depending on the function assigned to each function key as follows.

Function assigned to the function key	Display
Change or end the BGM pattern	Unlit: When the BGM pattern assigned to the function key is not being broadcast Lights: When the BGM pattern assigned to the function key is being broadcast
General-purpose broadcast pattern	Unlit: When the function key is OFF Flashes: When the function key is ON

[Volume Setting Display (ao5), Volume Setting Detail Display (ao6)]

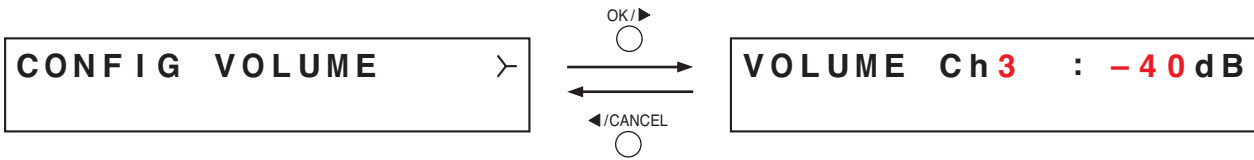

Indicates the output volume level set using the SX-2000 Setting Software in the output level meter. Besides, on the Volume Setting Detail Display screen, the set value for each output channel can be confirmed numerically.

Pressing the plus key increases the channel number by one and displays the setting value for that channel. Pressing the minus key decreases the channel number by one and displays the setting value for that channel.

When these screens are displayed, the entire fluorescent display is as follows:

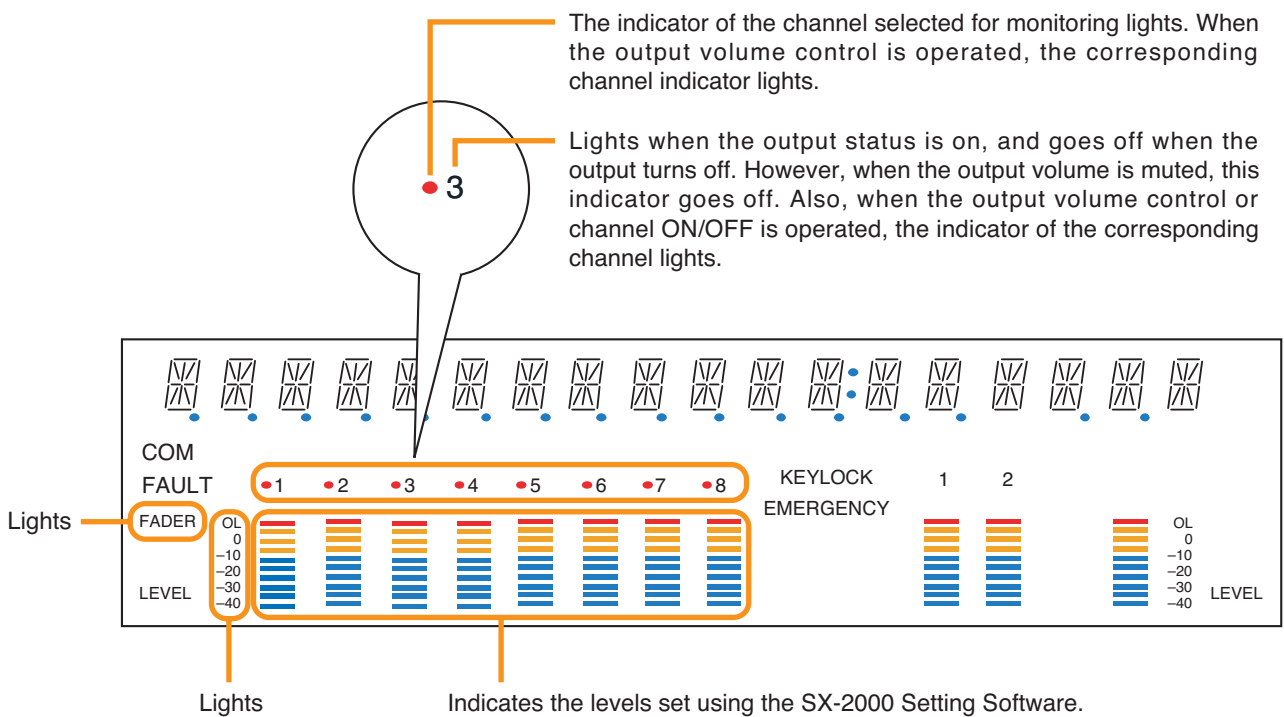

[Front Panel Volume Display (ao7), Front Panel Volume Detail Display (ao8)]

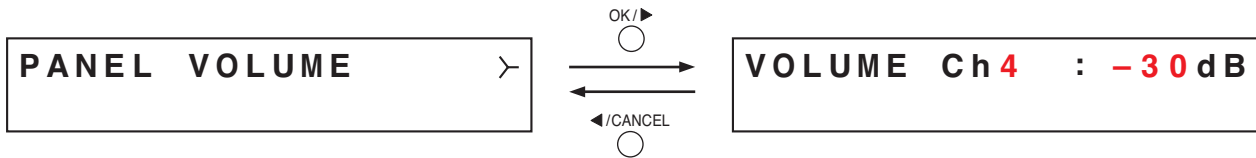

Indicates the output volume level set using the front panel's output volume control in the output level meter. Besides, on the Front Panel Volume Detail Display screen, the set value for each output channel can be confirmed numerically.

Pressing the plus key increases the channel number by one and displays the setting value for that channel. Pressing the minus key decreases the channel number by one and displays the setting value for that channel.

When these screens are displayed, the entire fluorescent display is as follows:

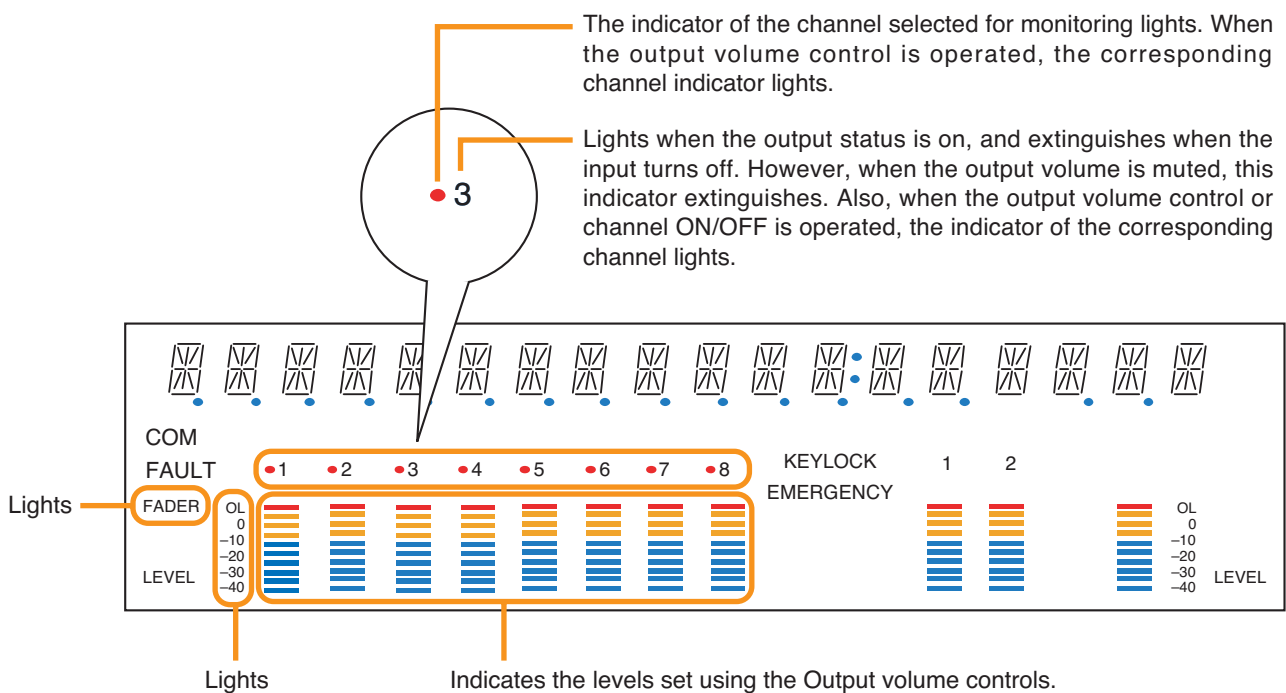

[Bus Selection Menu Display (ao9), Bus Selection Detail Display (ao10)]

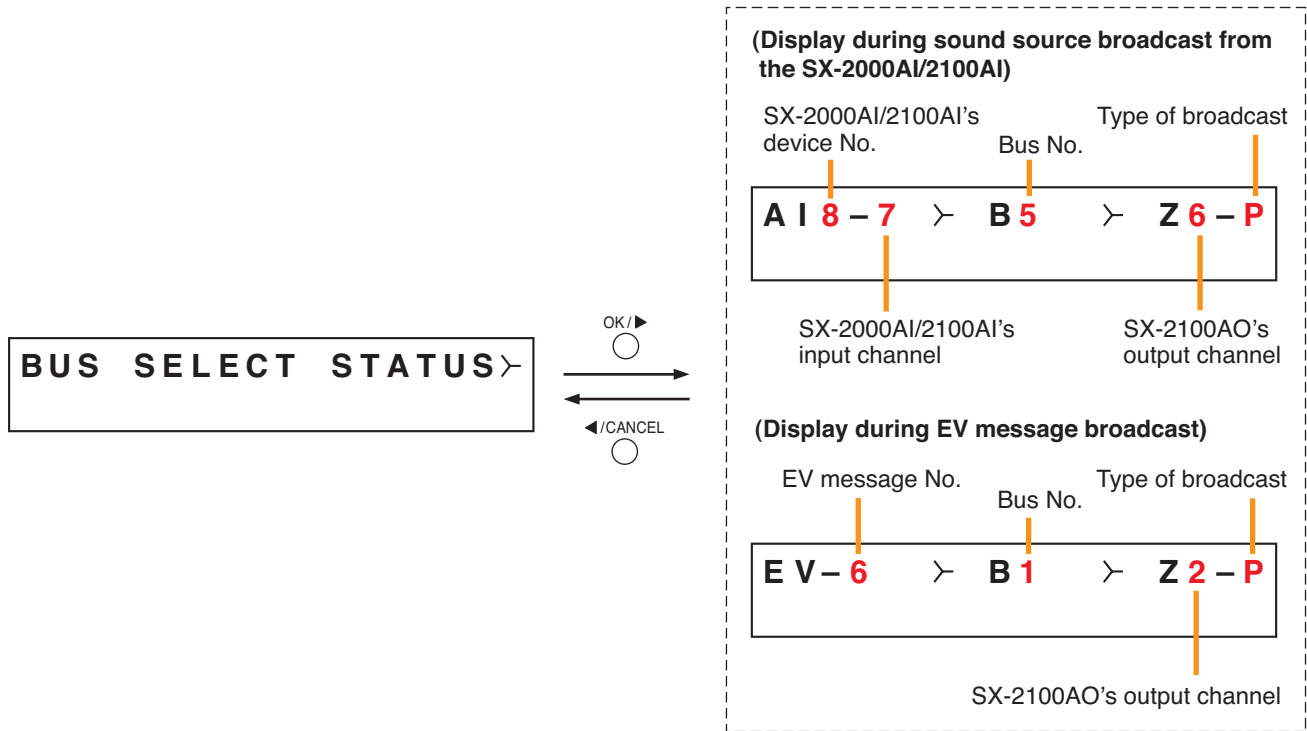

A "bus" is a path through which audio signals pass. The SX-2000 system has 16 bus lines. The Bus Selection Detail Display shows which input sound source is being sent to the SX-2100AO's output channel through which bus. Pressing the plus key increases the output channel number by one and displays the broadcast status for that channel. Pressing the minus key decreases the output channel number by one and displays the broadcast status for that channel.

Regarding the type of broadcast, "B" is displayed for BGM broadcasts, and "P" is displayed for general-purpose broadcasts or emergency broadcasts. This broadcast type indication alternates between "B" and "P" each time the OK key is pressed. For output channels not making broadcasts, the indication " - - - " is displayed for the SX-2000AI's and SX-2100AI's device No., for the SX-2000AI/2100AI's input channel, and for the bus No.

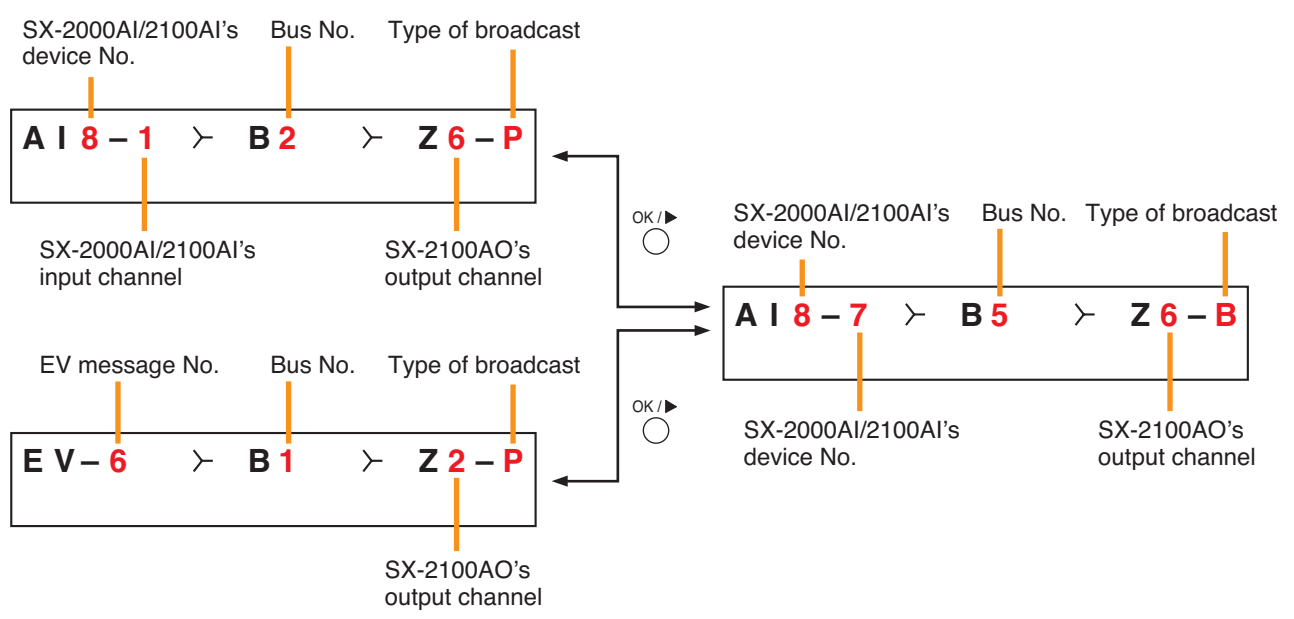

Note
BGM broadcasts cannot be made to the zones where an emergency broadcast is in progress. So, the indication " - - - " is displayed on the "BGM" Bus Display screen as shown at right while an emergency broadcast is being made.



When these screens are displayed, the entire fluorescent display is as follows:

The indicator of the channel selected for monitoring lights.
When the output volume control is operated, the corresponding channel indicator lights.

Indicates the unit's operating status when the corresponding channel key is pressed.
The indicator state differs depending on the function assigned to each channel key as follows.

Function assigned to the channel key	Display
Output ON/OFF	Unlit: When the output channel is OFF Lights: When the output channel is ON (The indicator state is "Unlit" when the output volume is muted.) When operating the corresponding output volume control or channel key
General-purpose broadcast pattern	Lights: When the channel key is OFF Flashes: When the channel key is ON

These indicators light when the Monitor ON/OFF key is set to ON.

Lights

Lights

Indicates the level being output from the SX-2100AO.

When the Monitor ON/OFF key is set to ON, this meter shows the signal level of the output channel being monitored.

[Control Input Status Display (ao11), Control Input Status Detail Display (ao12)]

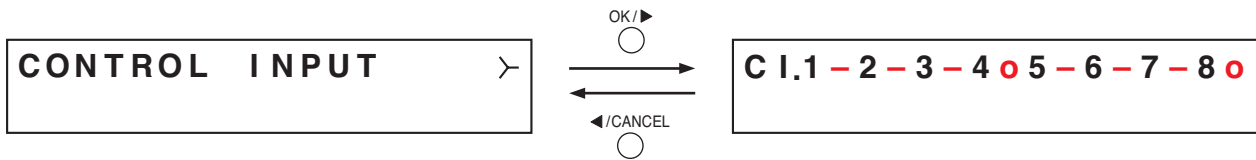

Displays the current control input status.

"o" is displayed when the control input is on, and "-" is displayed when the control input is off.

[Control Output Status Display (ao13), Control Output Status Detail Display (ao14)]

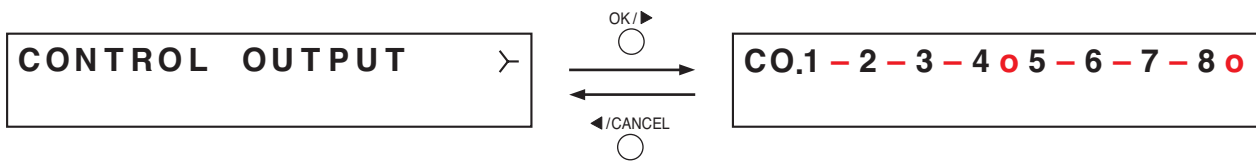

Displays the current control output status.

"o" is displayed when the control output is on, and "-" is displayed when the control output is off.

3.3.3. Equipment Information Display (ao15)



Display screen for menu item "Equipment Information."

[MAC Address Menu Display (ao16), MAC Address Display (ao17)]

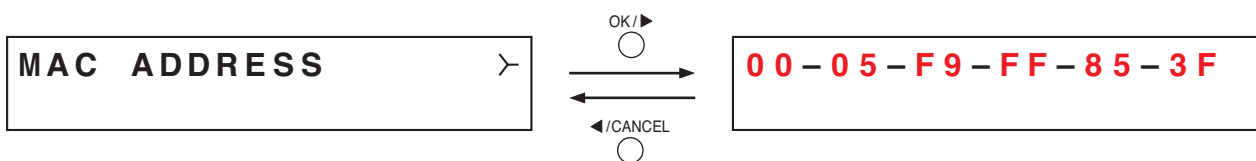

Displays the MAC address* set to the SX-2100AO on the Mac Address Display screen.

* A 12-digit hexadecimal address inherently assigned to and unique to a networking device.

[Equipment Version Display (ao18)]



Displays the SX-2100AO's firmware version.

[Sub CPU Version Display (ao19)]



Displays the version of software related to operations and displays on the SX-2100AO's front panel.

[SX-2000SM Version Display (ao20)]



Displays SX-2000SM firmware version. It appears when the communication with the SX-2000SM is complete. Before that, "Ver.-- --" is displayed on the version display section.

[Hardware Version Display (ao21), Hardware Version Detail Display (ao22)]

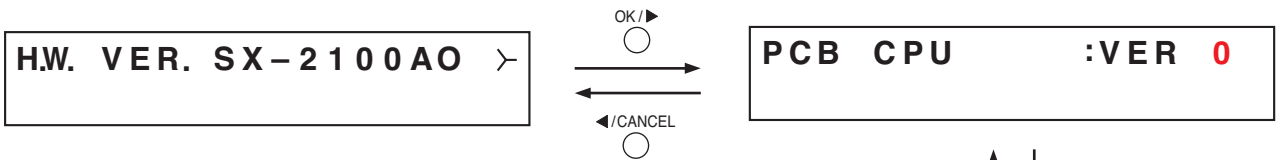

Displays the hardware version for each circuit board comprising the SX-2100AO unit. In the screens of Hardware Version Detail Display, pressing the plus or minus key advances or reverses the screen.

- PCB CPU: Displays the CPU circuit board version.
- PCB FRONT: Displays the front circuit board version.
- PCB POWER: Displays the power supply circuit board version.
- PCB LINK: Displays the link circuit board version.
- PCB SPEAKER: Displays the speaker circuit board version.

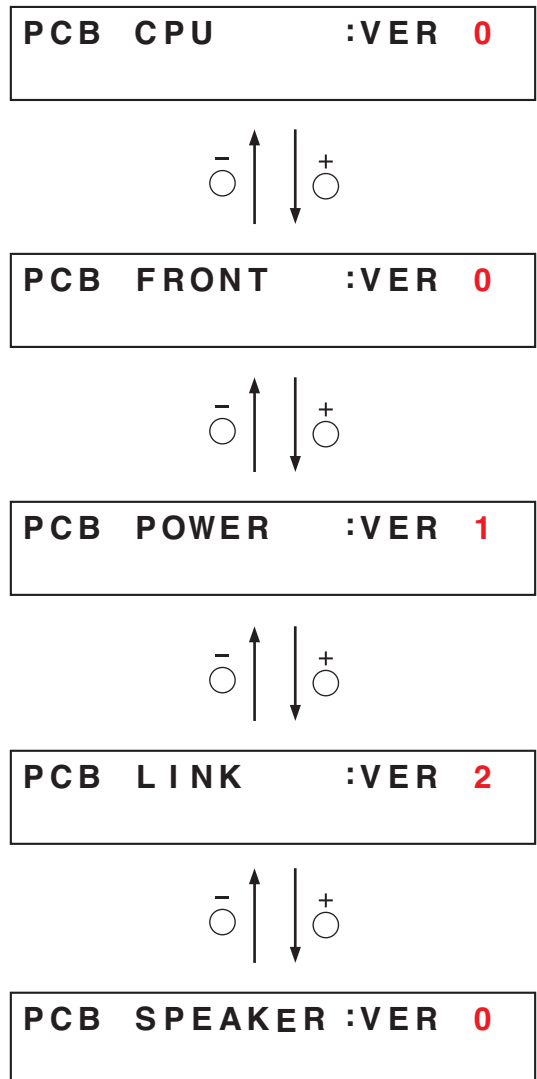

Chapter 6

SX-2000CI CONTROL INPUT UNIT

The SX-2000CI Control Input Unit is equipped with 32 control input channels, allowing various operations to be performed by connecting external equipment.

Fault detection function can be set to all the control inputs.

The SX-2000CI is a 1U-size* unit that can be mounted in an EIA equipment rack. It has 2 power supply inputs, one of which can be connected to a backup power source to protect against power failures.

*1U size = 44.5 mm (standard size)

1. NOMENCLATURE AND FUNCTIONS

[Front]

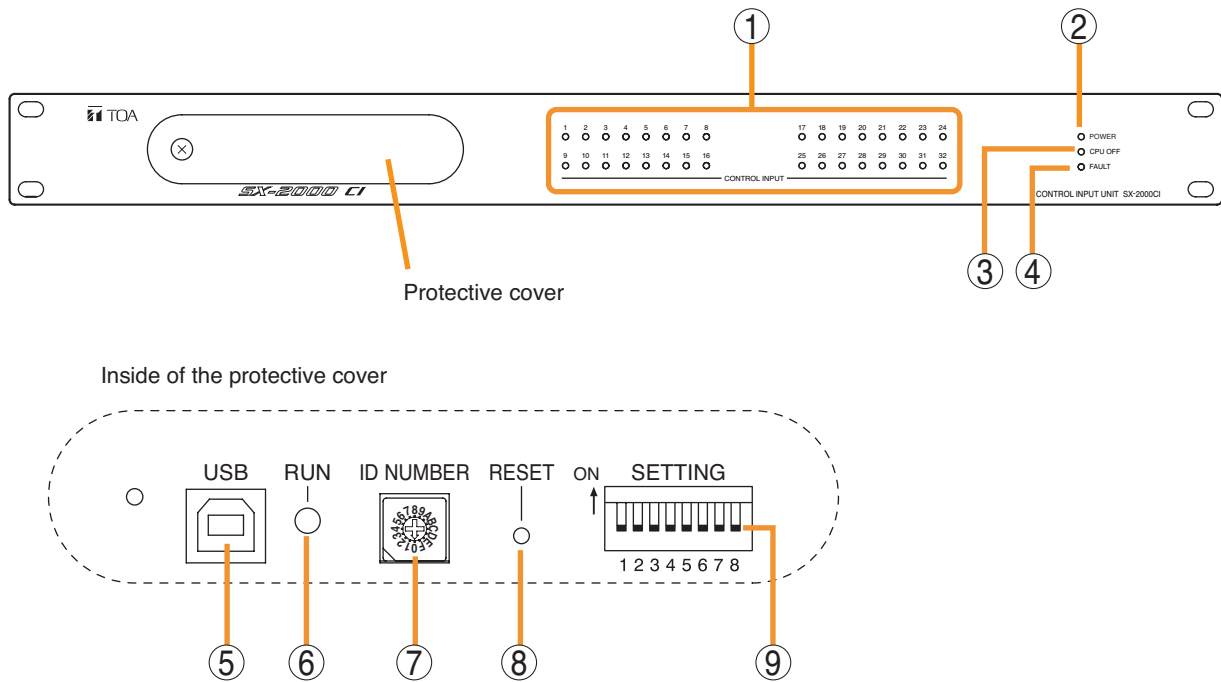

1. Control Input Indicators

[CONTROL INPUT 1 – 32] (Green)

Light when the corresponding control inputs are turned ON.

2. Power Indicator [POWER] (Blue)

Lights when the power is switched on.

3. CPU OFF Indicator [CPU OFF] (Red)

Lights while the general urgency all-call (CPU OFF state) is being made (p. 10-9).

4. FAULT Indicator [FAULT] (Yellow)

Lights while the general urgency all-call is being made (p. 10-9) or when communications to the SX-2000AO or SX-2100AO are interrupted for 5 seconds or more. Flashes when a failure is detected in the system.

5. USB Port [USB]

This port is not used.

6. RUN Indicator [RUN] (Green)

Normally flashes continuously.

Goes off while the general urgency all-call is being made (p. 10-9).

7. ID Switch [ID NUMBER]

This switch is not used.

Always set to "0."

Note

This switch is set to "0" by default.

8. Reset Key [RESET]

Pressing this key resets the SX-2000CI.

9. DIP Switch [SETTING]

These switches are not used.

Note

Switches 1 – 8 are set to the OFF position by default.

Chapter 7

SX-2000CO CONTROL OUTPUT UNIT

The SX-2000CO Control Output Unit is equipped with 32 control output channels, allowing various operations to be performed by connecting external equipment.

The SX-2000CO is a 1U-size* unit that can be mounted in an EIA equipment rack. It has 2 power supply inputs, one of which can be connected to a backup power source to protect against power failures.

*1U size = 44.5 mm (standard size)

1. NOMENCLATURE AND FUNCTIONS

[Front]

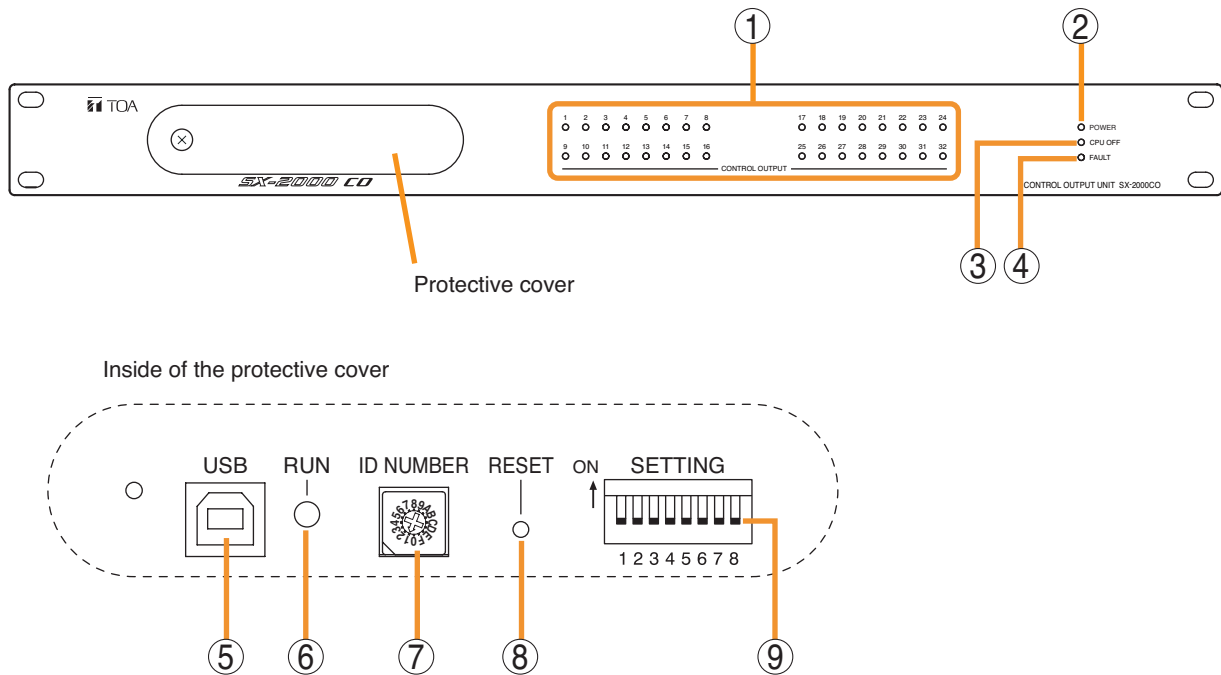

1. Control Output Indicators

[CONTROL OUTPUT 1 – 32] (Green)

Light when the corresponding control outputs are turned ON.

All indicators are factory-preset to go off because all control outputs are turned off when the general urgency all-call is made (p. 10-9).

By changing the internal DIP switch settings for the desired control outputs, the corresponding outputs can be turned ON, making the indicators light up when the general urgency all-call is made. (For details, see the separate Installation Manual, "Installation.")

2. Power Indicator [POWER] (Blue)

Lights when the power is switched on.

3. CPU OFF Indicator [CPU OFF] (Red)

Lights while the general urgency all-call (CPU OFF state) is being made (p. 10-9).

4. FAULT Indicator [FAULT] (Yellow)

Lights while general urgency all-call is being made (p. 10-9) or when communications to the SX-2000AO or SX-2100AO are interrupted for 5 seconds or more. Flashes when a failure is detected in the system.

5. USB Port [USB]

This port is not used.

6. RUN Indicator [RUN] (Green)

Normally flashes continuously.

Goes off while the general urgency all-call is being made (p. 10-9).

7. ID Switch [ID NUMBER]

This switch is not used.

Always set to "1."

Note

This switch is set to "1" by default.

8. Reset Key [RESET]

Pressing this key resets the SX-2000CO.

9. DIP Switch [SETTING]

These switches are not used.

Note

Switches 1 – 8 are set to the OFF position by default.

Chapter 8

RM-200SF

FIREMAN'S MICROPHONE

The RM-200SF Fireman's Microphone features 3 function keys, 1 emergency key, 1 talk key, and the indicator lamps associated with these keys. Functions are assigned to the function keys using the SX-2000 Setting Software.

Connecting RM-210 Remote Microphone Extension units (up to 5 units) to the RM-200SF expands the number of function keys and indicators in blocks of ten.

1. NOMENCLATURE AND FUNCTIONS

[Top]

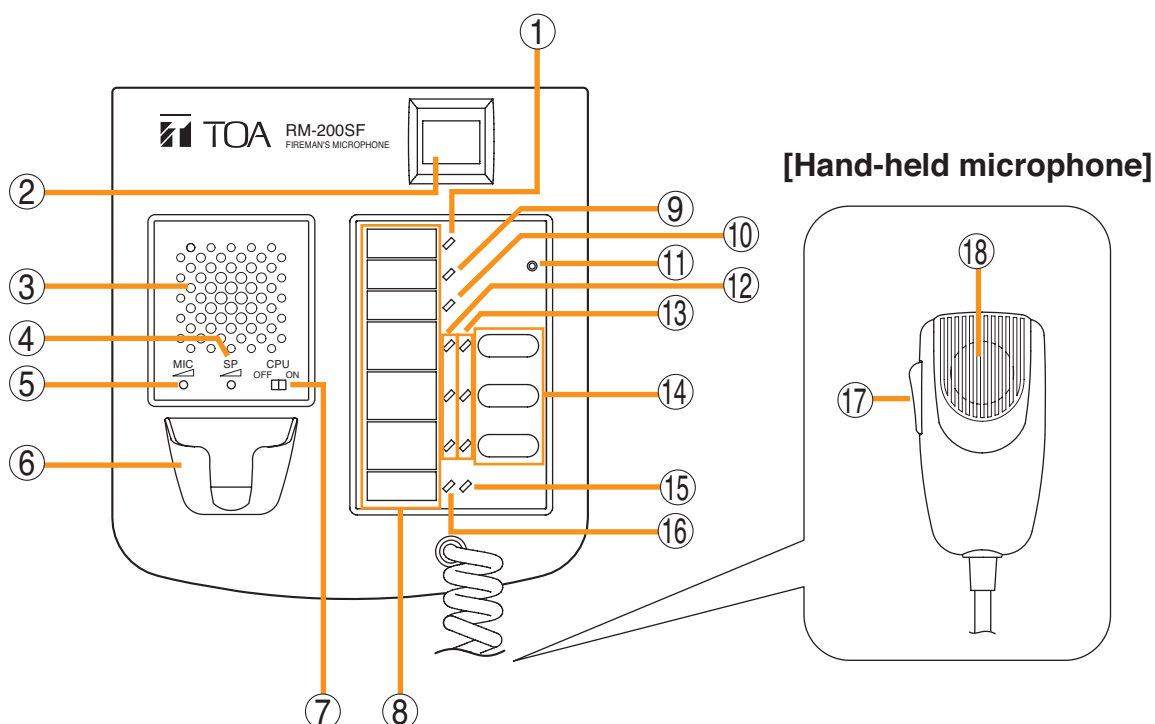

1. Power Indicator (Green)

Lights when the power is turned on.

2. Emergency Key

Assign emergency broadcast pattern start function to this key using the SX-2000 Setting Software. Lights when the SX-2000 system is in an emergency condition.

3. Monitor Speaker

Not used.

4. Monitor Speaker Volume Control [SP]

Not used.

5. Microphone Volume Control [MIC]

Adjusts the input sensitivity of the Hand-held Microphone.

6. Microphone Hanger

Used to hold the unit's Hand-held Microphone.

7. CPU Switch [CPU ON/OFF]

Normally set to ON. (Factory-preset: ON)
Setting this switch to OFF in combination with the DIP switch setting on the bottom surface allows the general urgency all-call to be made using a hand-held microphone by way of analog transmission not via the CPU control.

8. Indication Label Insert Slot

The label can be printed using the SX-2000 Setting Software. (See the separate Setting Software Instructions, "Printing Labels for Remote Microphones.")

9. Failure Indicator (Yellow/Red)

Flashes yellow if some problem within the system is detected.

This indicator will light yellow if the signal to the SX-2000AI or SX-2100AI to which the RM-200SF is connected is interrupted for 5 seconds or more.

Lights red when the unit is placed in reset state by pressing the Reset Switch (11).

10. CPU Indicator (Red)

Lights red when any one of the CPU switches on the RM-200SFs connected within the system is set to OFF or when the general urgency all-call is being made by any one of the RM-200SAs connected within the system.

11. Reset Switch

Used to reactivate the RM-200SF unit.
Holding down both this switch and the R3 key of the Function keys (14) for 2 seconds or more causes the Failure Indicator (9) to light red, placing the RM-200SF in reset state.

12. Status Indicators (Red/Yellow/Green)

Light, flash, or go off depending on the current operation state of function keys, failure state, or emergency state. (See [the next page](#).)

13. Selection Indicators (Green)

Light or go off depending on the current operation state of function keys. (See [the next page](#).)

14. Function Keys (R1 – R3)

Positioned in top-down order (R1, R2, R3). Pressing a specific function key executes the function that has been assigned to that key by the SX-2000 Setting Software.

Assignment of functions to specific keys is done using the SX-2000 Setting Software. (See the separate Setting Software Instructions, "Event Settings.")

15. Microphone Indicator (Green)

Lights or goes off depending on the current operation state of the Talk key.

16. Broadcast Status Indicator (Yellow/Green)

Lights, flashes, or goes off depending on the current operation state of the Talk key.

17. Talk Key

Press this key to broadcast a voice announcement. It must be pressed continuously for the duration of the broadcast.

18. Microphone

Used for voice announcements.

[Side]

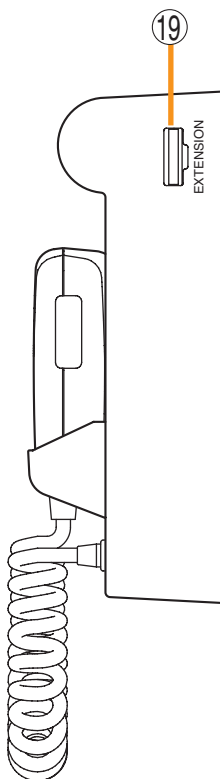

19. RM-210 Connection Terminal [EXTENSION]

Connect the RM-210 Remote Microphone Extension unit to this terminal.

2. INDICATOR STATUS

2.1. Indicators During Zone Selection







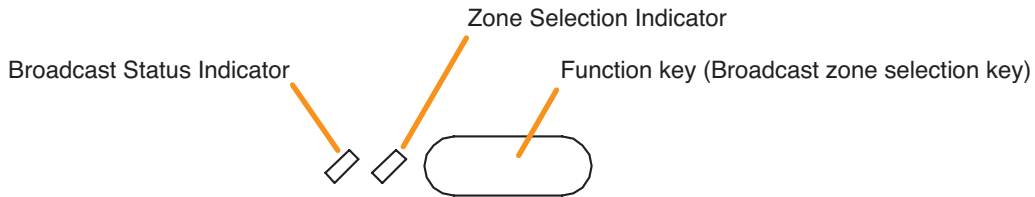

When a zone selection (pattern or individual) function has been assigned to a function key, the 2 indicators to the left of the key indicate its zone selection and broadcast status.

Note

For instructions on assigning functions to function keys, see the separate Setting Software Instructions, "Event Settings."





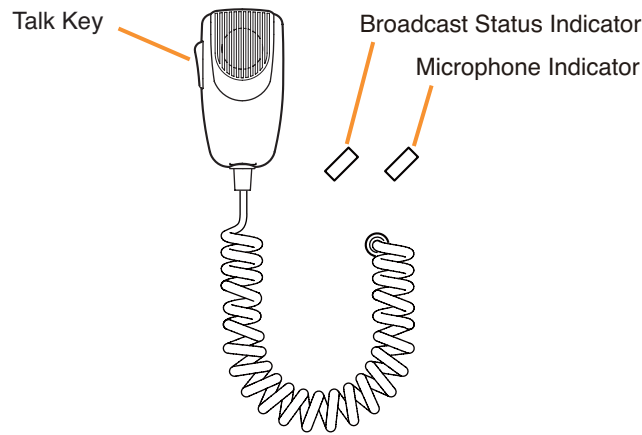

Indicator meanings are as follows:

Indicator	Status	Meaning
Zone Selection Indicator	Unlit 	No zone selected
	Lights green 	Zone selected
Broadcast Status Indicator	Unlit 	Zones assigned to this Broadcast Zone Selection key not in use or BGM broadcast in progress
	Flashes green 	A part of zones or the entire zone assigned to this Broadcast Zone Selection key is occupied by a broadcast from another device (secondary Remote Mic. or general EV message), or a part of zones is engaged by a broadcast from the primary Remote Mic (RM-200SF).
	Lights yellow 	All the zones selected by this Broadcast Zone Selection key on the primary Remote Microphone are engaged by a broadcast from the primary Remote Mic.
	Flashes yellow 	All the zones assigned to this Broadcast Zone Selection key are engaged by a broadcast from the Secondary Emergency Remote Mic.
	Lights red 	All the zones assigned to this Broadcast Zone Selection key are engaged by an evacuation message.
	Flashes red 	All the zones assigned to this Broadcast Zone Selection key are engaged by an alert message.
	Lights green 	All the zones assigned to this Broadcast Zone Selection key are engaged by a reset message.

2.2. Talk Key Indicators



The meanings of the 2 indicators located below the status and selection indicators are as follows:

Indicator	Status	Meaning
Microphone Indicator	Unlit 	Microphone not in use
	Lights green 	Microphone in use
Broadcast Status Indicator	Unlit 	Zone not in use (microphone announcement possible)
	Flashes green 	A part of zones or the entire zone selected by the primary Remote Mic is occupied by a general-purpose broadcast from another device (secondary Remote Mic, chime, etc.), or a broadcast from the primary Remote Mic is in progress in a part of the zones selected by the primary Remote Mic.
	Lights yellow 	All zones selected by the primary Remote Mic are engaged by a broadcast from the primary Remote Mic.

2.3. Indicators When Changing BGM Patterns



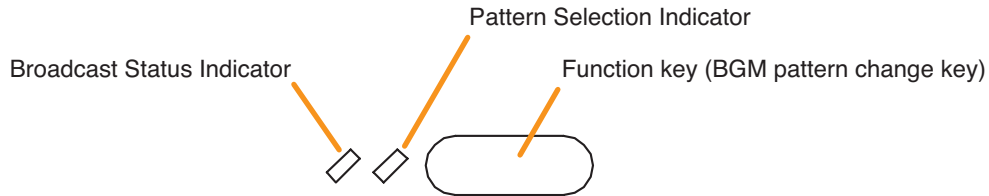

When a BGM pattern change function has been assigned to a function key, the 2 indicators to the left of the key indicate its pattern selection and broadcast status.

Note

For instructions on assigning functions to function keys, see the separate Setting Software Instructions, "Event Settings."



The meanings of the 2 indicators next to the Function Key are as follows:

Indicator	Status	Meaning
Pattern Selection Indicator	Unlit 	When the function key is not pressed
	Lights green 	When the function key is pressed (Lights briefly, then goes off)
Broadcast Status Indicator	Unlit 	When the BGM pattern assigned to the function key is not being broadcast
	Lights yellow 	When the BGM pattern assigned to the function key is being broadcast (including broadcasts activated by other devices)

2.4. Indicators During General-Purpose Pattern Broadcast



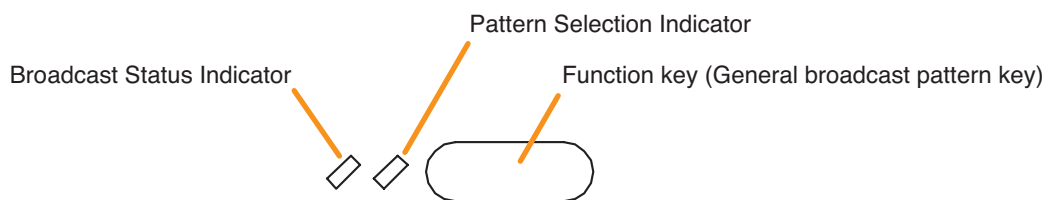

When a general-purpose broadcast pattern function has been assigned to a function key, the 2 indicators to the left of the key indicate its pattern selection and broadcast status.

Note

For instructions on assigning functions to function keys, see the separate Setting Software Instructions, "Event Settings."



The meanings of the 2 indicators next to the Function Key are as follows:

Indicator	Status	Meaning
Pattern Selection Indicator	Unlit 	When the function key is not selected
	Lights green 	When the function key is selected
Broadcast Status Indicator	Unlit 	When the broadcast pattern assigned to the function key is not being broadcast
	Flashes yellow 	When the broadcast pattern assigned to the function key is being broadcast

2.5. Indicators During Lamp Test

When the lamp test function has been assigned to the Function key, the 2 indicators to the left of the key indicate the running status of the lamp test.



Pressing the Lamp test key causes all indicators on the Primary Remote Mic to light, and the built-in buzzer to sound.

Notes

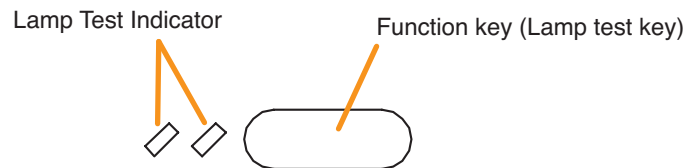
- For instructions on setting the failure detection function, see the separate Setting Software Instructions, "Basic Settings."
- For instructions on assigning functions to function keys, see the separate Setting Software Instructions, "Event Settings."



The meanings of the 2 indicators next to the Function Key are as follows:

Indicator	Status	Meaning
Lamp Test Indicator	Unlit 	When this Lamp test key is not pressed.
	Lights yellow and green 	Lamp test has been executed by pressing this Lamp test key.

2.6. Indicators on Failure Output Receipt

When the SX-2000 system is set to enable "Surveillance function," the failure output receipt function can be assigned to a function key.



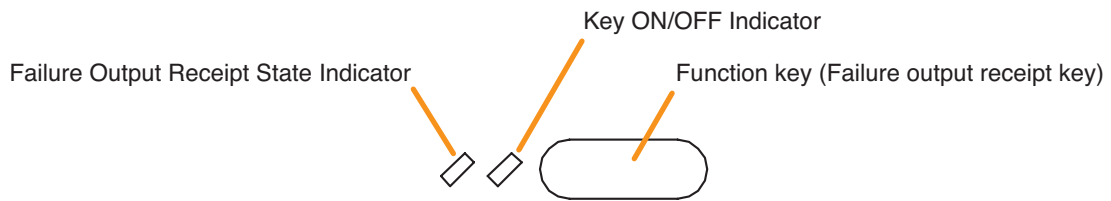

When the failure output receipt function has been assigned to the Function key, the 2 indicators to the left of the key indicate the occurrence and acknowledgement status of the failure output pattern.

Notes

- For instructions on setting the surveillance function, see the separate Setting Software Instructions, "Basic Settings."
- For instructions on assigning functions to function keys, see the separate Setting Software Instructions, "Event Settings."
- For instructions on assigning the failure output pattern, see the separate Setting Software Instructions, "Pattern Settings."



The meanings of the 2 indicators next to the Function Key are as follows:

Indicator	Status	Meaning
Key ON/OFF Indicator	Unlit 	When this Failure output receipt key is not pressed.
	Lights green 	When this Failure output receipt key is pressed. (as long as it is pressed.)
Failure Output Receipt State Indicator	Flashes yellow 	When the failure output pattern assigned to this Failure output receipt key has occurred.
	Lights yellow 	Failure Output Pattern has been acknowledged after pressing this Failure output receipt key.

2.7. Indicators at the Time of Failure Output Reset

When the SX-2000 system is set to enable "Surveillance function," the failure output reset function can be assigned to a function key.



When the failure output reset function has been assigned to the Function key, the failure status indicator can be reset by pressing the key. The indicator to the left of the key lights only when the key is pressed.

Notes

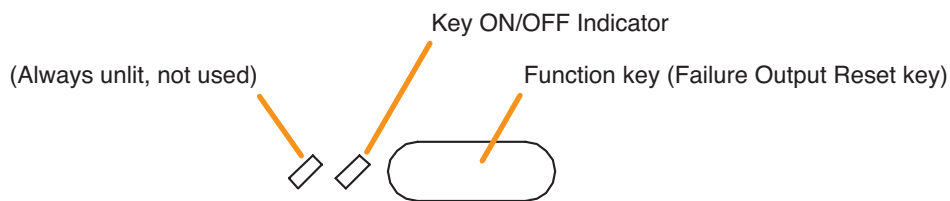
- For instructions on setting surveillance function, see the separate Setting Software Instructions, "Basic Settings."
- For instructions on assigning functions to function keys, see the separate Setting Software Instructions, "Event Settings."
- For instructions on assigning failure output pattern, see the separate Setting Software Instructions, "Pattern Settings."



The meanings of the 2 indicators next to the Function Key are as follows:

Indicator	Status	Meaning
Key ON/OFF Indicator	Unlit 	When this Failure output reset key is not pressed.
	Lights green 	When this Failure output reset key is pressed. (as long as it is pressed.)

2.8. Indicator State at the Time of Emergency Broadcast Pattern Start

When the system is set to "Emergency," the emergency broadcast pattern start function can be assigned to the Emergency key or function key.

Pressing the function-assigned key causes the emergency broadcast to start.

Assigning this function to the Emergency key causes the key to light or go off, indicating the emergency state of the SX-2000 system.

Meanwhile, when a function key is assigned this function, the 2 indicators next to the key indicate the emergency start and emergency states of the SX-2000 system.

Notes

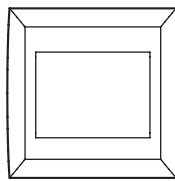

- For the emergency function settings, refer to the separate Setting Software Instructions, "Basic Settings."
- For instructions on assigning functions to the emergency key and function keys, see the separate Setting Software Instructions, "Event Settings."

[When assigned to the Emergency key]



Emergency key



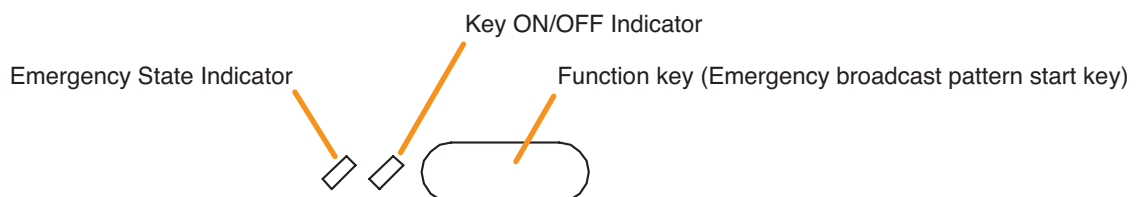

The key's lighting state indicates the system conditions as shown in the table below.

Indicator	Status	Meaning
Emergency Key Indicator	Unlit 	The SX-2000 system is not in an emergency condition.
	Lights red 	The Emergency Broadcast Pattern is started by pressing this Emergency key or the SX-2000 system is in an emergency condition.

[When assigned to the function key]



The meanings of the 2 indicators next to the Function Key are as follows:

Indicator	Status	Meaning
Key ON/OFF Indicator	Unlit 	This Emergency broadcast pattern start key is not pressed.
	Lights green 	This Emergency broadcast pattern start key is pressed. (as long as it is pressed)
Emergency State Indicator	Unlit 	Emergency Broadcast Pattern assigned to this Emergency broadcast pattern start key is not broadcast.
	Lights red 	Emergency Broadcast Pattern assigned to this Emergency broadcast pattern start key is broadcast.

2.9. Indicator State at the Time of Emergency Broadcast Pattern Stop

When the system is set to "Emergency," the emergency broadcast pattern stop function can be assigned to the Function key.



Pressing the function-assigned key causes the emergency broadcast pattern to stop. The indicator to the left of the key lights only when the key is pressed.

Notes

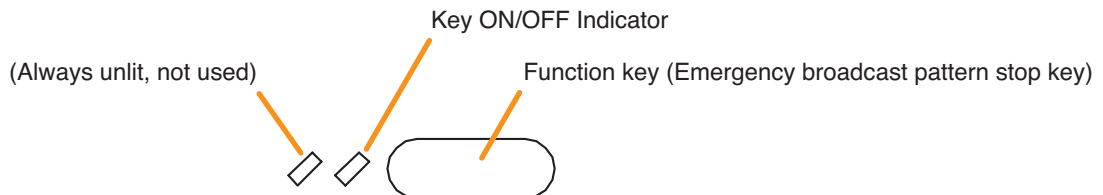
- For the emergency function settings, refer to the separate Setting Software Instructions, "Basic Settings."
- For instructions on assigning functions to the function keys, see the separate Setting Software Instructions, "Event Settings."



The meanings of the 2 indicators next to the Function Key are as follows:

Indicator	Status	Meaning
Key ON/OFF Indicator	Unlit 	When this Emergency broadcast pattern stop key is not pressed.
	Lights green 	When this Emergency broadcast pattern stop key is pressed. (as long as it is pressed.)

2.10. Indicator State at the Time of Emergency Sequence Stop

When the system is set to "Emergency," the emergency sequence stop function can be assigned to the Function key.



Pressing the function-assigned key causes all the emergency broadcast patterns including the set emergency sequence to stop. The indicator to the left of the key lights only when the key is pressed.

Notes

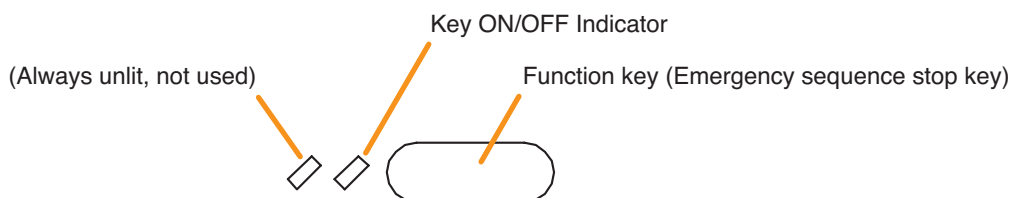
- For the emergency function settings, refer to the separate Setting Software Instructions, "Basic Settings."
- For instructions on assigning functions to the function keys, see the separate Setting Software Instructions, "Event Settings."



The meanings of the 2 indicators next to the Function Key are as follows:

Indicator	Status	Meaning
Key ON/OFF Indicator	Unlit 	When this Emergency sequence stop key is not pressed.
	Lights green 	When this Emergency sequence stop key is pressed. (as long as it is pressed.)

2.11. Indicator State at the Time of Emergency Sequence Phase Shift

When the system is set to "Emergency," the emergency sequence phase shift function can be assigned to a function key.

Pressing the function-assigned key causes the set emergency sequence to shift to the next phase.



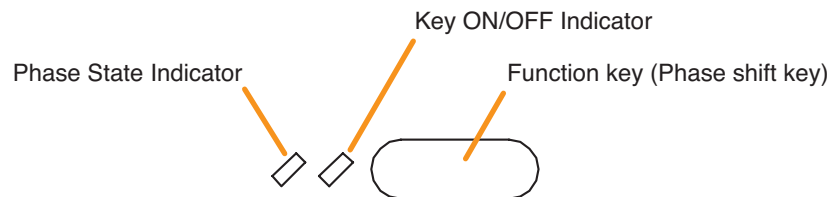

The 2 indicators next to the Function key indicate the emergency sequence phase state.

Notes

- For the emergency function settings, refer to the separate Setting Software Instructions, "Basic Settings."
- For instructions on assigning functions to function keys, see the separate Setting Software Instructions, "Event Settings."



The meanings of the 2 indicators next to the Function Key are as follows:

Indicator	Status	Meaning
Key ON/OFF Indicator	Unlit 	This Phase shift key is not pressed.
	Lights green 	This Phase shift key is pressed. (as long as it is pressed)
Phase State Indicator	Lights green 	Emergency sequence Phase 1 is assigned to this Phase shift key.
	Flashes green 	Emergency sequence Phase 2 is assigned to this Phase shift key.
	Unlit 	Emergency sequence Phase 3 is assigned to this Phase shift key.

2.12. Indicator State at the Time of Emergency Reset



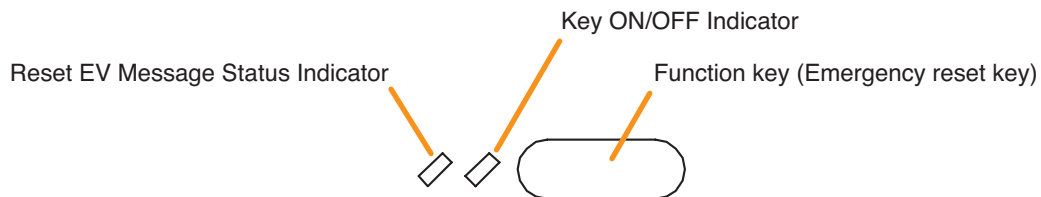

When the system is set to "Emergency," the emergency reset function can be assigned to the Function key. Pressing the function-assigned key causes all the activated emergency broadcast patterns to stop, allowing the emergency broadcast status to be reset after the reset EV message broadcast completion. The 2 indicators next to the Function key indicate the emergency reset state.

Notes

- For the emergency function settings, refer to the separate Setting Software Instructions, "Basic Settings."
- For instructions on assigning functions to function keys, see the separate Setting Software Instructions, "Event Settings."



The meanings of the 2 indicators next to the Function Key are as follows:

Indicator	Status	Meaning
Key ON/OFF Indicator	Unlit 	This Emergency reset key is not pressed.
	Lights green 	This Emergency reset key is pressed. (as long as it is pressed)
Reset EV Message Status Indicator	Unlit 	Reset EV Message broadcast assigned to this Emergency reset key is being stopped.
	Lights green 	Reset EV Message broadcast assigned to this Emergency reset key is being activated.

Chapter 9

RM-200SA REMOTE MICROPHONE

RM-210 REMOTE MICROPHONE EXTENSION

The RM-200SA Remote Microphone features 13 function keys, 1 covered key, 1 talk key, and the indicator lamps associated with these. Functions are assigned to the function keys using the SX-2000 Setting Software.

Connecting RM-210 Remote Microphone Extension (maximum 4) to the RM-200SA expands the number of function keys and indicators in blocks of ten.

1. NOMENCLATURE AND FUNCTIONS

1.1. RM-200SA

[Top]

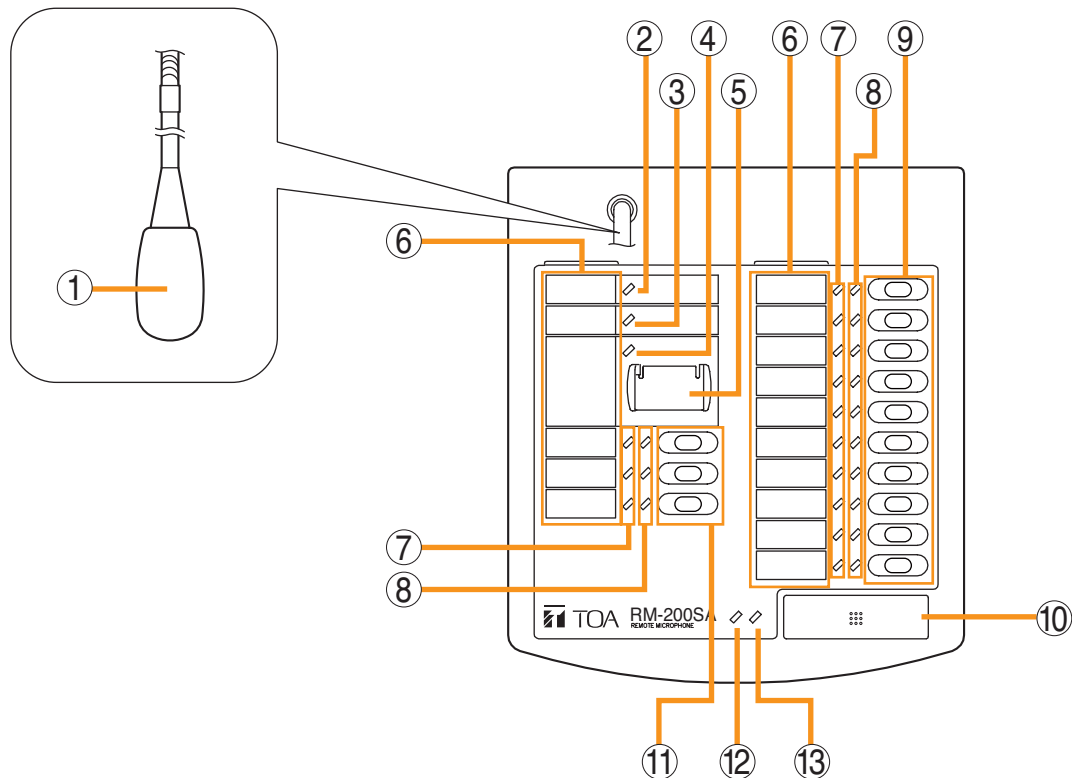

1. Microphone

Used for voice announcements.

2. Power Indicator (Green)

Lights when the power is turned on.

3. Failure Indicator (Yellow/Red)

Flashes yellow if some problem within the system is detected.

This indicator will light yellow if the signal to the SX-2000AI or SX-2100AI to which the RM-200SA is connected is interrupted for 5 seconds or more. This indicator will light red while the general urgency all-call is being made (p. 10-9) or the RM-200SA is in the reset process.

4. Emergency Indicator (Red)

Lights when the SX-2000 system is in an emergency condition.

5. Emergency/General Urgency All-Call Key (Covered)

When the Emergency Broadcast Pattern Start function has been assigned to this key by the SX-2000 Setting Software, pressing it activates the emergency broadcast from the SX-2000 system. Independently of settings made by the SX-2000 Setting Software, holding down this key for 4 seconds or more in combination with DIP switch

(14) setting causes the CPU to be bypassed, enabling the general urgency all-call to be made by way of analog transmissions. (See p. 10-9.)

6. Indication Label Insert Slots

Labels can be printed using the SX-2000 Setting Software. (See the separate Setting Software Instructions, "Printing Labels for Remote Microphones.")

7. Status Indicators (Red/Yellow/Green)

Light, flash, or go off depending on the current operation state of function keys, failure state, or emergency state. (See p. 9-5)

8. Selection Indicators (Green)

Light or go off depending on the current operation state of function keys (p. 9-5).

9. Function Keys (R1 – R10)

Positioned in top-down order (R1, R2 ... R10). Pressing a specific function key executes the function that has been assigned to that key by the SX-2000 Setting Software.

Assignment of functions to specific keys is done using the SX-2000 Setting Software. (See the separate Setting Software Instructions, "Event Settings.")

10. Talk Key

Press this key to broadcast a voice announcement. If the Talk key is set to "PTT" ("press-to-talk") mode, then it must be pressed continuously for the duration of the broadcast. If the Talk key is set to "Lock" mode, then it must be pressed once to turn the microphone on at the beginning of a broadcast, then pressed again to turn the microphone off once the broadcast is finished.

The microphone can also be set to sound a chime at the beginning and/or end of each broadcast.

The Talk key mode ("PTT" or "Lock") and the chime function are set using the SX-2000 Setting Software. The RM-200SA of which "Type" is set to "General/Emergency" on the SX-2000 Setting software is fixed to "PTT" mode for the Talk key with no chime activation. (See the separate Setting Software Instructions, "System Settings.")

11. Function Keys (L1 – L3)

Positioned in top-down order (L1, L2, L3).

These keys operate in the same manner as the Function keys (R1 – R10) (No. 9).

12. Broadcast Status Indicator (Yellow/Green)

Lights, flashes, or goes off depending on the current operation state of the Talk key.

13. Microphone Indicator (Green)

Lights or goes off depending on the current operation state of the Talk key.

Flashes while the chime is being activated.

[Side]

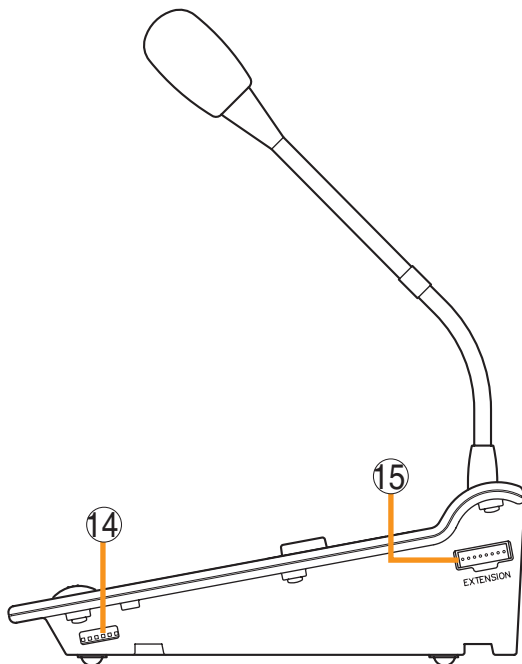

14. DIP Switch

Used to assign device numbers, set the CPU OFF function (general urgency all-call) to enabled or disabled, etc.

(For making general urgency all-calls, see [p. 10-9](#), and for setting DIP switch, see the separate Installation Manual, "Installation.")

15. RM-210 Extension Connector

This port is used to connect RM-210 extension units.

1.2. RM-210

[Top]

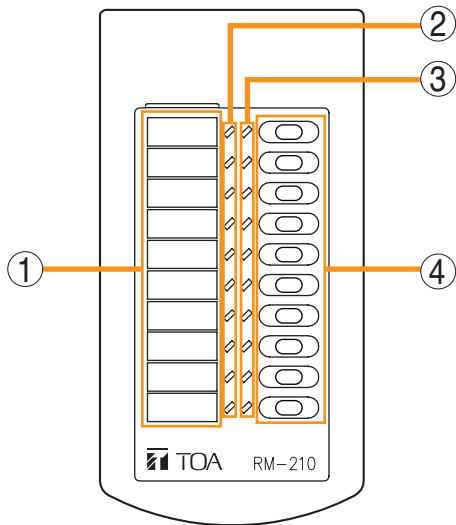

1. Indication Label Insert Slot

The label can be printed using the SX-2000 Setting Software. (See the separate Setting Software Instructions, "Printing Labels for Remote Microphones.")

2. Status Indicators (Red/Yellow/Green)

Light, flash, or go off depending on the current operation state of function keys, failure state, or emergency state. (See [p. 9-5](#))

3. Selection Indicators (Green)

Light or go off depending on the current operation state of function keys ([p. 9-5](#)).

4. Function Keys (1 – 10)

Positioned in top-down order (1, 2 ... 10).

Pressing a specific function key executes the function that has been assigned to that key by the SX-2000 Setting Software.

Assignment of functions to specific keys is done using the SX-2000 Setting Software. (See the separate Setting Software Instructions, "Event Settings.")

2. INDICATOR STATUS

2.1. Indicators During Zone Selection







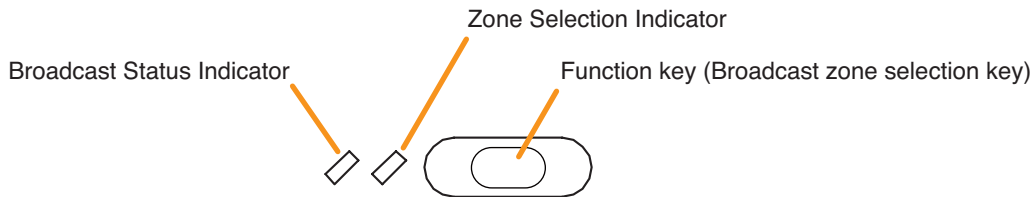

When a zone selection (pattern or individual) function has been assigned to a function key, the 2 indicators to the left of the key indicate its zone selection and broadcast status.

Note

For instructions on assigning functions to function keys, see the separate Setting Software Instructions, "Event Settings."







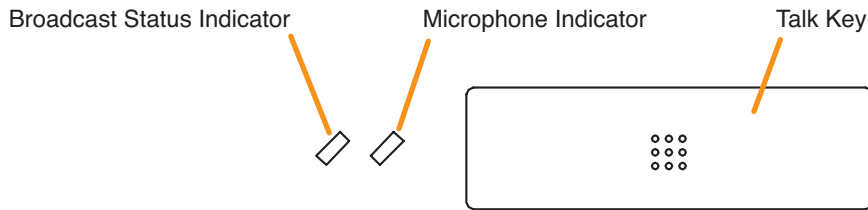

Indicator meanings are as follows:

Indicator	Status	Meaning
Zone Selection Indicator	Unlit 	No zone selected
	Lights green 	Zone selected
Broadcast Status Indicator	Unlit 	Zones assigned to this Broadcast Zone Selection key not in use or BGM broadcast in progress
	Flashes green 	A part of zones or the entire zone assigned to this Broadcast Zone Selection key is occupied by a broadcast from another device (secondary Remote Mic. or general EV message), or a part of zones is engaged by a broadcast from the primary Remote Mic (RM-200SA).
	Lights yellow 	All the zones selected by this Broadcast Zone Selection key on the primary Remote Microphone are engaged by a broadcast from the primary Remote Mic.
	Flashes yellow 	All the zones assigned to this Broadcast Zone Selection key are engaged by a broadcast from the Secondary Emergency Remote Mic.
	Lights red 	All the zones assigned to this Broadcast Zone Selection key are engaged by an evacuation message.
	Flashes red 	All the zones assigned to this Broadcast Zone Selection key are engaged by an alert message.
	Lights green 	All the zones assigned to this Broadcast Zone Selection key are engaged by a reset message.

2.2. Talk Key Indicators



The meanings of the 2 indicators next to the Talk Key are as follows:

Indicator	Status	Meaning
Microphone Indicator	Unlit 	Microphone not in use
	Lights green 	Microphone in use
	Flashes green 	Chime broadcast in progress from the primary Remote Mic.
Broadcast Status Indicator	Unlit 	Zone not in use (microphone announcement possible)
	Flashes green 	A part of zones or the entire zone selected by the primary Remote Mic is occupied by a broadcast from another device (secondary Remote Mic, chime, etc.), or a broadcast from the primary Remote Mic is in progress in a part of the zones selected by the primary Remote Mic.
	Lights yellow 	All zones selected by the primary Remote Mic are engaged by a broadcast from the primary Remote Mic.

2.3. Indicators When Changing BGM Patterns



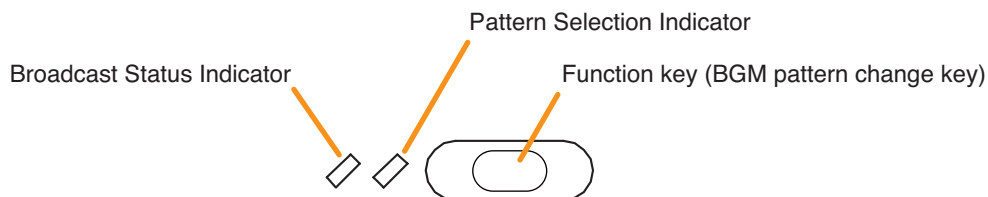

When a BGM pattern change function has been assigned to a function key, the 2 indicators to the left of the key indicate its pattern selection and broadcast status.

Note

For instructions on assigning functions to function keys, see the separate Setting Software Instructions, "Event Settings."



The meanings of the 2 indicators next to the Function Key are as follows:

Indicator	Status	Meaning
Pattern Selection Indicator	Unlit 	When the function key is not pressed
	Lights green 	When the function key is pressed (Lights briefly, then extinguishes)
Broadcast Status Indicator	Unlit 	When the BGM pattern assigned to the function key is not being broadcast
	Lights yellow 	When the BGM pattern assigned to the function key is being broadcast (including broadcasts activated by other devices)



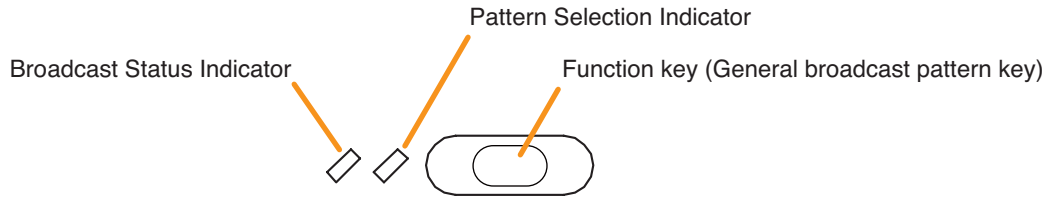

2.4. Indicators During General-Purpose Pattern Broadcast

When a general-purpose broadcast pattern function has been assigned to a function key, the 2 indicators to the left of the key indicate its pattern selection and broadcast status.

Note: For instructions on assigning functions to function keys, see the separate Setting Software Instructions, "Event Settings."



The meanings of the 2 indicators next to the Function Key are as follows:

Indicator	Status	Meaning
Pattern Selection Indicator	Unlit 	When the function key is not selected
	Lights green 	When the function key is selected
Broadcast Status Indicator	Unlit 	When the broadcast pattern assigned to the function key is not being broadcast
	Flashes yellow 	When the broadcast pattern assigned to the function key is being broadcast



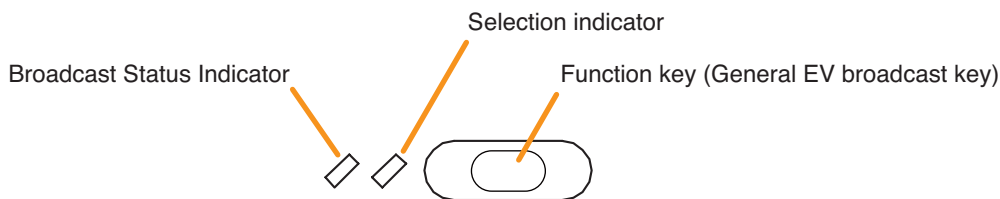

2.5. Indicators During General EV Broadcasts

When a general EV broadcast function has been assigned to a function key, the 2 indicators to the left of the key indicate its selection and broadcast statuses.

Note: For instructions on assigning functions to function keys, see the separate Setting Software Instructions, "Event Settings."



The meanings of the 2 indicators next to the Function Key are as follows:

Indicator	Status	Meaning
Selection Indicator	Unlit 	When the function key is not pressed
	Lights green 	When the unit is brought in general EV broadcast by pressing the function key
Broadcast Status Indicator	Unlit 	When a general EV message assigned to the function key is not activated.
	Lights green 	When a general EV message assigned to the function key is being broadcast from the equipment other than the Remote Mic.
	Lights yellow 	When a general EV message assigned to the function key is being broadcast from the primary Remote Mic. or other Remote Mic.

2.6. Indicators Showing RM Broadcast Status



The Broadcast status indicator to the left of the Function key indicates the current broadcast status of other Remote Mic.

Note

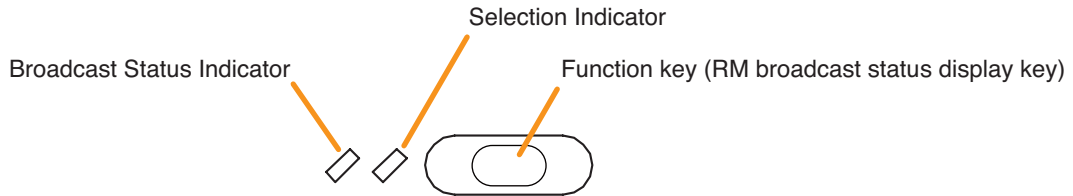
For instructions on assigning functions to function keys, see the separate Setting Software Instructions, "Event Settings."



The meanings of the 2 indicators next to the Function Key are as follows:

Indicator	Status	Meaning
Broadcast Status Indicator	Unlit 	When the Remote Mic. assigned to the function key is not engaged in broadcasting
	Lights yellow 	When the Remote Mic. assigned to the function key is engaged in broadcasting

2.7. Indicators During Lamp Test

When the type of the RM-200SA is set to "Emergency/General," the lamp test function can be assigned to the Function key.

When the lamp test function has been assigned to the Function key, the 2 indicators to the left of the key indicate the running status of the lamp test.



Pressing the Lamp Test key causes all indicators on the Primary Remote Mic to light, and the built-in buzzer to sound.

Notes

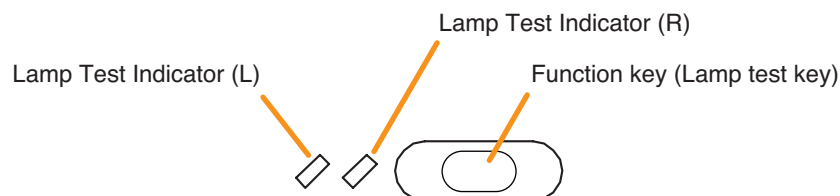
- For instructions on setting the surveillance function, see the separate Setting Software Instructions, "Basic Settings."
- For the type of the RM-200SA settings, see the separate Setting Software Instructions, "System Settings."
- For instructions on assigning functions to function keys, see the separate Setting Software Instructions, "Event Settings."



The meanings of the 2 indicators next to the Function Key are as follows:

Indicator	Status	Meaning
Lamp Test Indicator	Unlit 	When this Lamp test key is not pressed.
	Lights yellow and green 	Lamp test has been executed by pressing this Lamp test key.

2.8. Indicators on Failure Output Receipt

When the SX-2000 system is set to enable "Surveillance function," the failure output receipt function can be assigned to a function key.



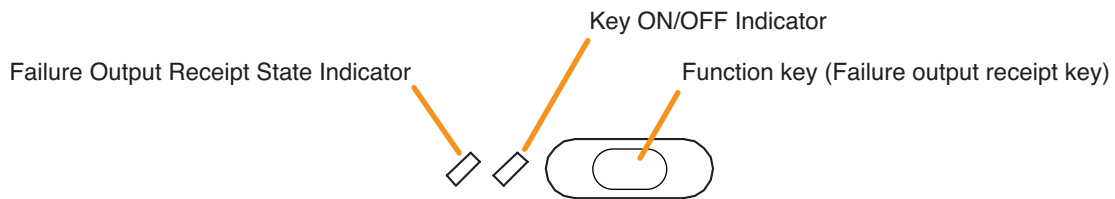

When the failure output receipt function has been assigned to the Function key, the 2 indicators to the left of the key indicate the occurrence and failure output receipt status of the failure output pattern.

Notes

- For instructions on setting the surveillance function, see the separate Setting Software Instructions, "Basic Settings."
- For instructions on assigning functions to function keys, see the separate Setting Software Instructions, "Event Settings."
- For instructions on assigning the failure output pattern, see the separate Setting Software Instructions, "Pattern Settings."



The meanings of the 2 indicators next to the Function Key are as follows:

Indicator	Status	Meaning
Key ON/OFF Indicator	Unlit 	When this Failure output receipt key is not pressed.
	Lights green 	When this Failure output receipt key is pressed. (as long as it is pressed.)
Failure Output Receipt State Indicator	Flashes yellow 	When the failure output pattern assigned to this Failure output receipt key has occurred.
	Lights yellow 	Failure output pattern has been acknowledged after pressing this Failure output receipt key.

2.9. Indicators at the Time of Failure Output Reset

When the SX-2000 system is set to enable "Surveillance function," the failure output reset function can be assigned to a function key.



When the failure output reset function has been assigned to the Function key, the failure status indicator can be reset by pressing the key. The indicator to the left of the key lights only when the key is pressed.

Notes

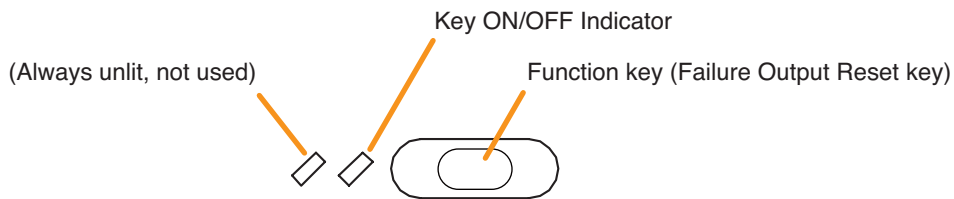
- For instructions on setting the surveillance function, see the separate Setting Software Instructions, "Basic Settings."
- For instructions on assigning functions to function keys, see the separate Setting Software Instructions, "Event Settings."
- For instructions on assigning failure output pattern, see the separate Setting Software Instructions, "Pattern Settings."



The meanings of the 2 indicators next to the Function Key are as follows:

Indicator	Status	Meaning
Key ON/OFF Indicator	Unlit 	When this Failure output reset key is not pressed.
	Lights green 	When this Failure output reset key is pressed. (as long as it is pressed.)

2.10. Indicator State at the Time of Emergency Broadcast Pattern Start

When the system is set to "Emergency" and the type of the RM-200SA to "Emergency/General," the emergency broadcast pattern start function can be assigned to the covered key or Function key.

Pressing the function-assigned key causes the emergency to start.

When the covered key is assigned this function, the Emergency Indicator next to the key indicates the emergency condition of the SX-2000 system.

Meanwhile, when a function key is assigned this function, the 2 indicators next to the key indicate the emergency start and emergency states of the SX-2000 system.



Notes

- For the emergency function settings, refer to the separate Setting Software Instructions, "Basic Settings."
- For the type of the RM-200SA settings, see the separate Setting Software Instructions, "System Settings."
- For instructions on assigning functions to the covered key and function keys, see the separate Setting Software Instructions, "Event Settings."

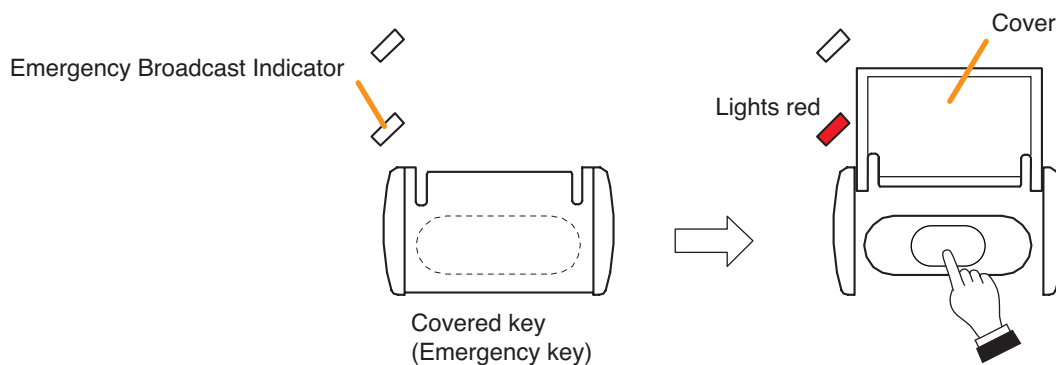
[When assigned to the covered key]





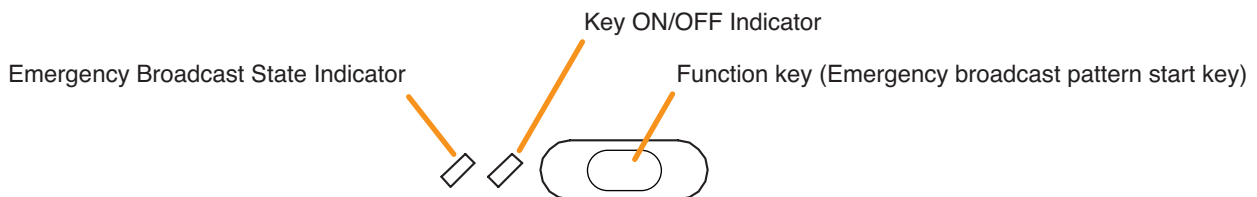

The meanings of the indicator next to the covered key is as follows:

Indicator	Status	Meaning
Emergency Broadcast Indicator	Unlit 	The SX-2000 system is not in an emergency condition.
	Lights red 	The Emergency Broadcast Pattern is started by pressing this Emergency key or the SX-2000 system is in an emergency condition.

[When assigned to the function key]



The meanings of the 2 indicators next to the Function Key are as follows:

Indicator	Status	Meaning
Key ON/OFF Indicator	Unlit 	This Emergency broadcast pattern start key is not pressed.
	Lights green 	This Emergency broadcast pattern start key is pressed. (as long as it is pressed)
Emergency Broadcast State Indicator	Unlit 	Emergency Broadcast Pattern assigned to this Emergency broadcast pattern start key is not broadcast.
	Lights red 	Emergency Broadcast Pattern assigned to this Emergency broadcast pattern start key is broadcast.

2.11. Indicator State at the Time of Emergency Broadcast Pattern Stop

When the system is set to "Emergency" and the type of the RM-200SA to "Emergency/General," the emergency broadcast pattern stop function can be assigned to the Function key.



Pressing the function-assigned key causes the emergency broadcast pattern to stop. The indicator to the left of the key lights only when the key is pressed.

Notes

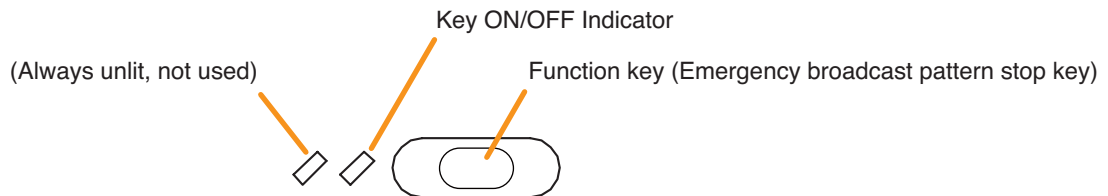
- For the emergency function settings, refer to the separate Setting Software Instructions, "Basic Settings."
- For the type of the RM-200SA settings, see the separate Setting Software Instructions, "System Settings."
- For instructions on assigning functions to the function keys, see the separate Setting Software Instructions, "Event Settings."



The meanings of the 2 indicators next to the Function Key are as follows:

Indicator	Status	Meaning
Key ON/OFF Indicator	Unlit 	When this Emergency broadcast pattern stop key is not pressed.
	Lights green 	When this Emergency broadcast pattern stop key is pressed. (as long as it is pressed.)

2.12. Indicator State at the Time of Emergency Sequence Stop

When the system is set to "Emergency" and the type of the RM-200SA to "Emergency/General," the emergency sequence stop function can be assigned to the Function key.



Pressing the function-assigned key causes the emergency sequence to stop. The indicator to the left of the key lights only when the key is pressed.

Notes

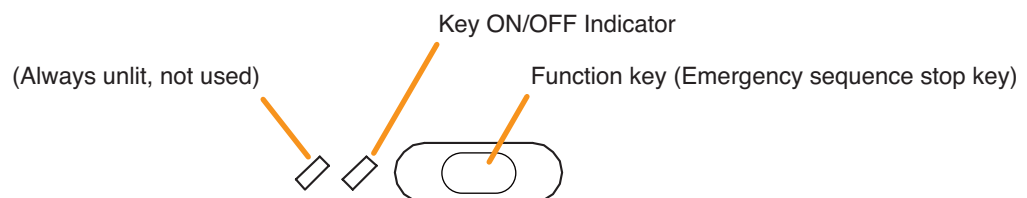
- For the emergency function settings, refer to the separate Setting Software Instructions, "Basic Settings."
- For the type of the RM-200SA settings, see the separate Setting Software Instructions, "System Settings."
- For instructions on assigning functions to the function keys, see the separate Setting Software Instructions, "Event Settings."



The meanings of the 2 indicators next to the Function Key are as follows:

Indicator	Status	Meaning
Key ON/OFF Indicator	Unlit 	When this Emergency sequence stop key is not pressed.
	Lights green 	When this Emergency sequence stop key is pressed. (as long as it is pressed.)

2.13. Indicator State at the Time of Emergency Sequence Phase Shift

When the system is set to "Emergency" and the type of the RM-200SA to "Emergency/General," the emergency sequence phase shift function can be assigned to a function key.



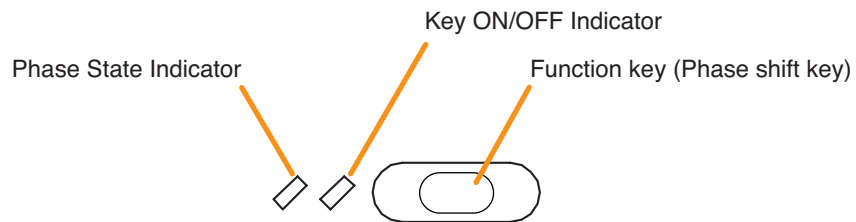

Assigning this function to the Function key causes the 2 indicators next to the Function key to indicate the emergency sequence phase state.

Notes

- For the emergency function settings, refer to the separate Setting Software Instructions, "Basic Settings."
- For the type of the RM-200SA settings, see the separate Setting Software Instructions, "System Settings."
- For instructions on assigning functions to function keys, see the separate Setting Software Instructions, "Event Settings."



The meanings of the 2 indicators next to the Function Key are as follows:

Indicator	Status	Meaning
Key ON/OFF Indicator	Unlit 	This Phase shift key is not pressed.
	Lights green 	This Phase shift key is pressed. (as long as it is pressed)
Phase State Indicator	Lights green 	Emergency sequence Phase 1 is assigned to this Phase shift key.
	Flashes green 	Emergency sequence Phase 2 is assigned to this Phase shift key.
	Unlit 	Emergency sequence Phase 3 is assigned to this Phase shift key.

2.14. Indicator State at the Time of Emergency Reset

When the system is set to "Emergency" and the type of the RM-200SA to "Emergency/General," the emergency reset function can be assigned to a function key.



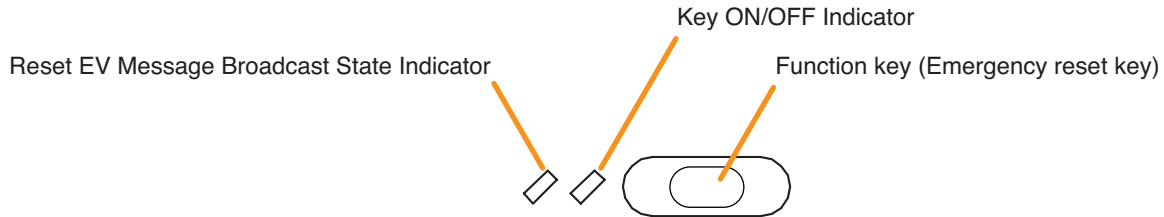

Assigning this function to the Function key causes the 2 indicators next to the Function key to indicate the emergency reset state.

Notes

- For the emergency function settings, refer to the separate Setting Software Instructions, "Basic Settings."
- For the type of the RM-200SA settings, see the separate Setting Software Instructions, "System Settings."
- For instructions on assigning functions to function keys, see the separate Setting Software Instructions, "Event Settings."



The meanings of the 2 indicators next to the Function Key are as follows:

Indicator	Status	Meaning
Emergency Reset Indicator	Unlit 	This Emergency reset key is not pressed.
	Lights green 	This Emergency reset key is pressed. (as long as it is pressed)
Reset EV Message Broadcast State Indicator	Unlit 	Reset Message broadcast assigned to this Emergency reset key is being stopped.
	Lights green 	Reset Message broadcast assigned to this Emergency reset key is being activated.

Chapter 10

OPERATION

1. BGM AND GENERAL BROADCASTING

1.1. Broadcasting from the SX-2000AI, SX-2100AI, SX-2000AO, or SX-2100AO

The front-mounted function keys or channel keys can be used to make broadcasts.

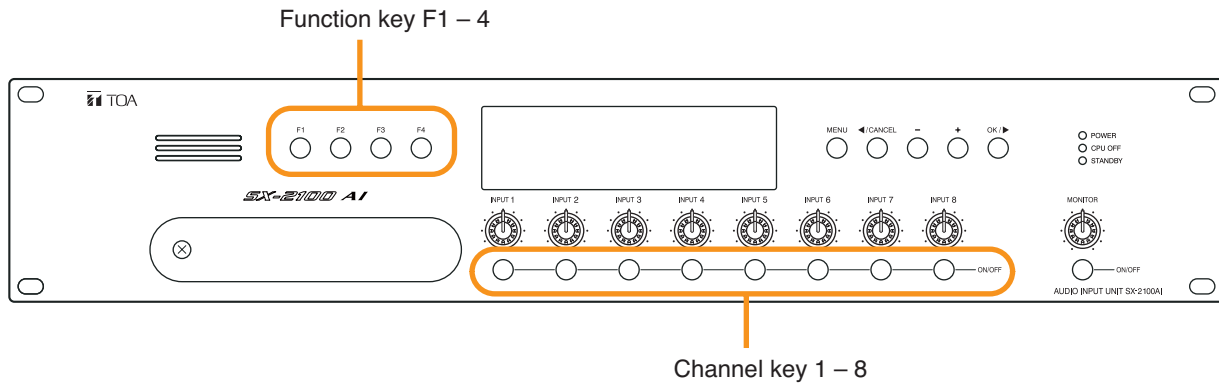

Note: The figure shows the SX-2100AI.

1.1.1. Broadcasting using the function key

Function keys F1 – F4 on the front panel can be used to change or end the BGM pattern, or to activate or end the general-purpose pattern broadcast.

For instructions on assigning functions to function keys, see the separate Setting Software Instructions, "Event Settings."

[Setting example to function keys]

Key	Item Name	Function
Function key F1	BGM pattern 1	Activation of BGM pattern 1 broadcast
Function key F2	BGM pattern 2	Activation of BGM pattern 2 broadcast
Function key F3	BGM end	End of BGM
Function key F4	General broadcast pattern 1	Activation and end of general broadcast pattern 1 broadcast

[BGM Broadcast Example]

Following is the operation example in the case where BGM broadcast is made by the BGM pattern 1 in the morning and changed to the BGM pattern 2 in the afternoon, and then ended.

Step 1. Press function key F1 (BGM pattern 1) to activate BGM pattern 1 broadcast.

Step 2. Press function key F2 (BGM pattern 2) to switch BGM pattern 1 broadcast to BGM pattern 2 broadcast.

Step 3. Press function key F3 (BGM end) to end BGM.

[General-Purpose Pattern Broadcast Example]

Following is the operation example in the case when the general broadcast pattern 1 is activated, and then ended.

Step 1. Press function key F4 (general broadcast pattern 1) to activate general broadcast pattern 1 broadcast.

Step 2. Press function key F4 (general broadcast pattern 1) to end general broadcast pattern 1 broadcast.

1.1.2. Broadcasting using the channel key

Channel keys 1 – 8 on the front panel can be used to activate or end the general-purpose pattern broadcast. For instructions on assigning functions to channel keys, see the separate Setting Software Instructions, "Control Input Settings."

[Setting example to channel keys]

Channel Key	Item Name	Function
1	ON/OFF	Channel 1 ON/OFF
2	ON/OFF	Channel 2 ON/OFF
3	ON/OFF	Channel 3 ON/OFF
4	ON/OFF	Channel 4 ON/OFF
5	ON/OFF	Channel 5 ON/OFF
6	ON/OFF	Channel 6 ON/OFF
7	ON/OFF	Channel 7 ON/OFF
8	General broadcast pattern 2	Activation and end of general broadcast pattern 2 broadcast

[General-Purpose Pattern Broadcast Example]

Following is the operation example in the case when the general broadcast pattern 2 is activated, and then ended.

Step 1. Press channel key 8 (general broadcast pattern 2) to activate general broadcast pattern 2 broadcast.

Step 2. Press channel key 8 (general broadcast pattern 2) again to end general broadcast pattern 2 broadcast.

1.2. Broadcasting from the RM-200SF, RM-200SA, and RM-210

The function keys can be used to make microphone announcements, to change or end BGM broadcasts, and to activate or end general-purpose and general EV broadcasts.

For instructions on assigning functions to function keys, see the separate Setting Software Instructions, "Event Settings."

The example here shows the RM-200SA, but the basic operation and displays are the same for the RM-200SF and RM-210.

[Setting example to function keys]

Key	Item Name	Function
Function key R1	Zones 1, 2 and 3	Zone selection (pattern)
Function key R2	Zone 1	Zone selection (individual)
Function key R3	Zone 2	Zone selection (individual)
Function key R4	Zone 3	Zone selection (individual)
Function key R5	Zone clear	Reset the selected zone.
Function key R6	General broadcast pattern 1	Activation and end of general broadcast pattern 1 broadcast
Function key R7	General EV broadcast	Activation and end of general EV message broadcast
Function key L1	BGM pattern 1	Activation of BGM pattern 1 broadcast
Function key L2	BGM pattern 2	Activation of BGM pattern 2 broadcast
Function key L3	BGM end	End of BGM
Talk key		Lock type, Start Chime: 1, End Chime: None

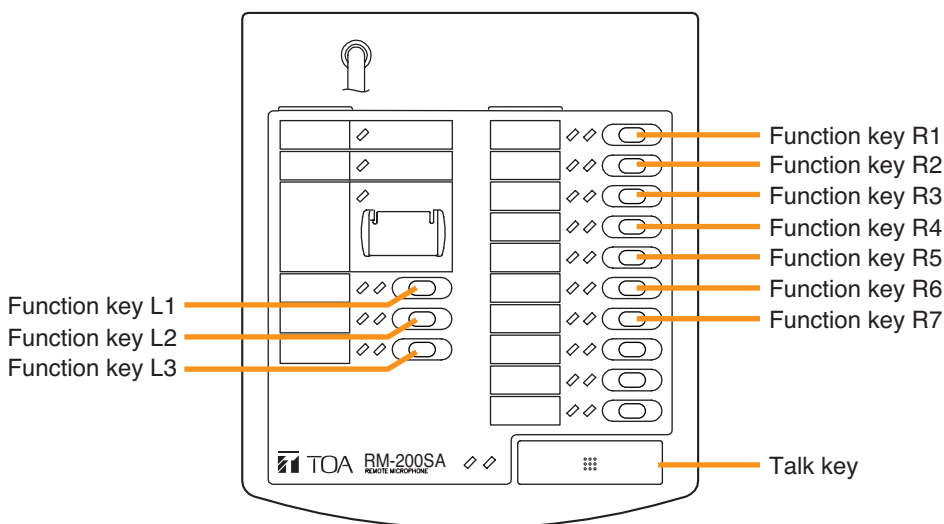

1.2.1. Example of broadcasting to the selected (pattern-designated) zone

Step 1. Press Function key R1 (zones 1, 2 and 3).
All of the designated zones are selected, and the zone selection indicator next to Function key R1 lights green.

Note
To cancel the selection, press Function key R1 again, or press Function key R5 (zone clear).
The zone selection indicator will go off.

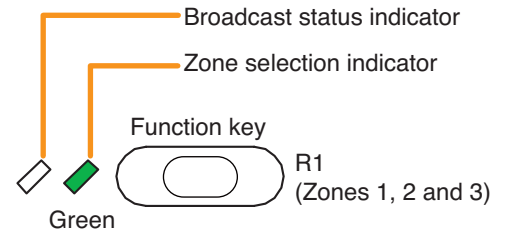

Step 2. Press the Talk key.
A chime will be broadcast. This chime will be audible through the monitor speaker built in the RM-200SA.

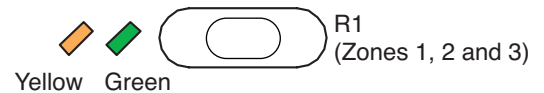

The Microphone indicator flashes green while the chime is being activated. (RM-200SA only)

Note
Pressing the Talk key again while the chime is being activated causes the chime to stop, ending the broadcast in progress.

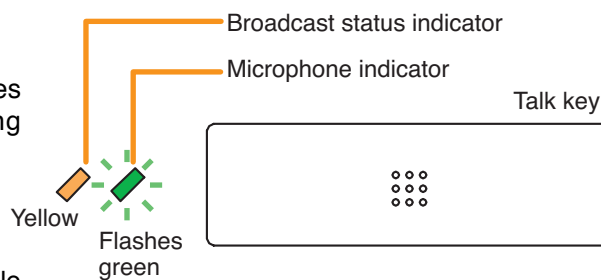

Step 3. When the microphone indicator next to the Talk key lights green, make the microphone announcement.
The zones assigned to Function keys R2 – R4 are included within the zone selection pattern assigned to Function key R1. Therefore, the broadcast status indicators next to Function keys R2 – R4 will light yellow in the same way.

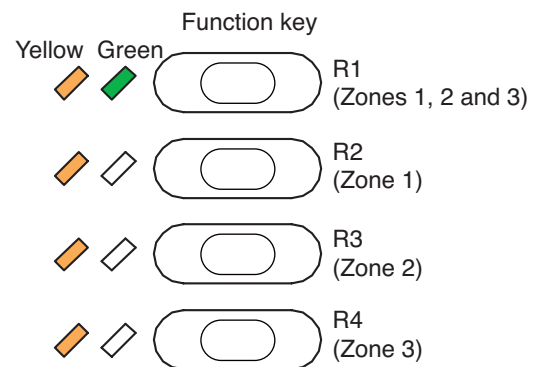

Step 4. Press the Talk key.
The broadcast ends.



Step 5. Press Function key R5 (zone clear).
The zone selection is cancelled.

Note
If it is desired that the zone selection be left unchanged, there is no need to clear the selected zones.

1.2.2. Example of broadcasting to the selected (individual) zone

Step 1. Press Function key R2 (zone 1) and Function key R3 (zone 2).
Zones 1 and 2 are selected, and their zone selection indicators light green.

Note

To cancel a selected zone, press the Function key for that zone again. The zone selection indicator for that key will go off.

To cancel all selected zones, press Function key R5 (zone clear). Both zone selection indicators will go off.

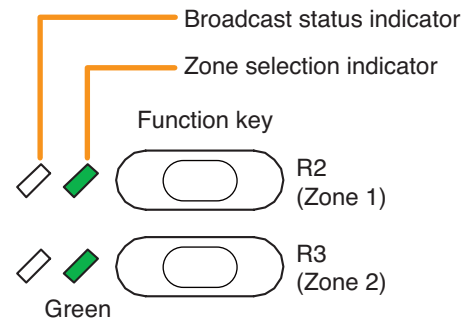

Step 2. Press the Talk key.
A chime will be broadcast. This chime will be audible through the monitor speaker built in the RM-200SA.

The Microphone indicator flashes green while the chime is being activated. (RM-200SA only)

Note

Pressing the Talk key again while the chime is being activated causes the chime to stop, ending the broadcast in progress.

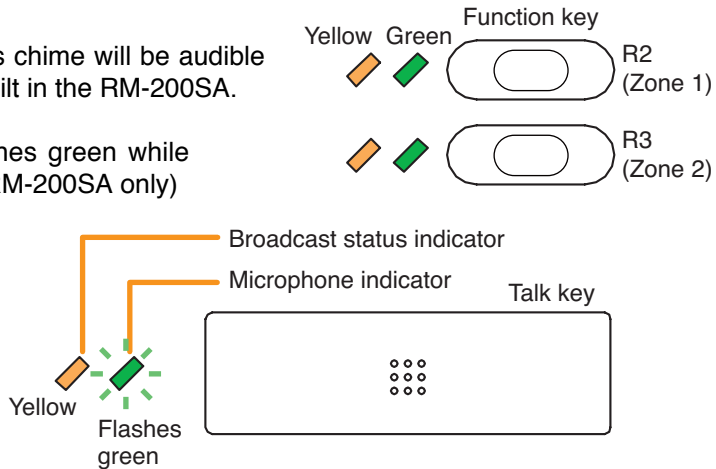

Step 3. When the microphone indicator next to the Talk key lights green, make the microphone announcement.
Because a portion of the pattern assigned to Function key R1 is included in the selected zones, the broadcast status indicator next to this key will flash green.

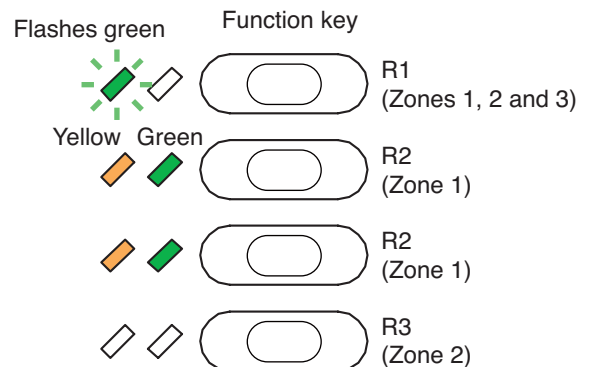

Step 4. Press the Talk key.
The broadcast ends.



Step 5. Press Function key R5 (zone clear).
The zone selection is cancelled.

Note

If it is desired that the zone selection be left unchanged, there is no need to clear the selected zones.

1.2.3. Example of BGM broadcasting

Following is the operation example in the case where BGM broadcast is made by the BGM pattern 1 in the morning and changed to the BGM pattern 2 in the afternoon, and then ended.

Step 1. Press the Function key L1 (BGM pattern 1).
BGM pattern 1 is selected and activated.
After the pattern selection indicator next to Function key L1 lights green then goes off, the broadcast status indicator lights yellow.

Note

To cancel the selection, press Function key L3 (BGM end). The broadcast status indicator will go off.

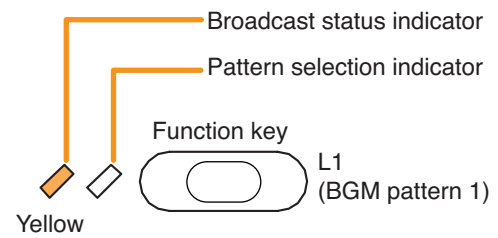

Step 2. Press the Function key L2 (BGM pattern 2).
BGM pattern 2 is selected, ending BGM pattern 1, and BGM pattern 2 is activated.
After the pattern selection indicator next to Function key L2 lights green then goes off, the broadcast status indicator lights yellow.
The broadcast status indicator next to Function key L1 goes off.

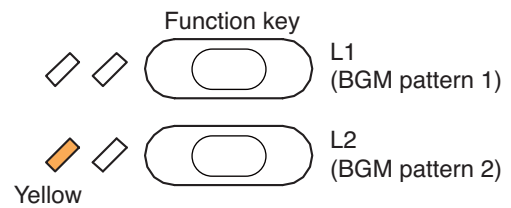

Step 3. Press the Function key L3 (BGM end).
BGM ends. All indicators go off.

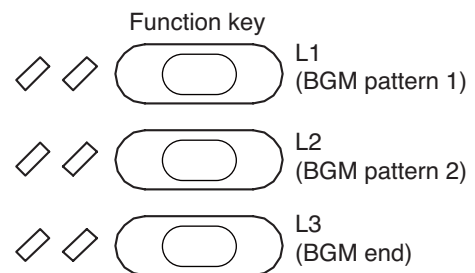

1.2.4. Example of general broadcasting

Step 1. Press the Function key R6 (general broadcast pattern 1).
General broadcast pattern 1 is selected and activated.
After the selection indicator next to Function key R6 lights green, the broadcast status indicator flashes yellow.

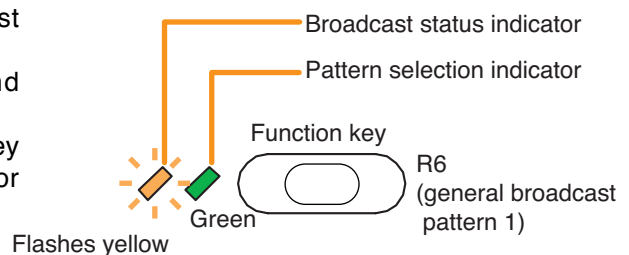

Step 2. Press the Function key R6 (general broadcast pattern 1) again.
General broadcast pattern 1 being activated stops.
The pattern selection indicator and the broadcast status indicator next to Function key R6 go off.

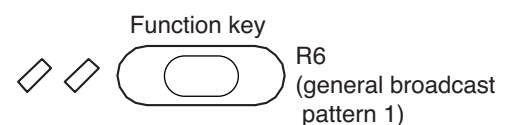

1.2.5. Example of general EV broadcasting

Here, an operation example based on the zone patterns is explained.

Step 1. Press the function key R1 (zones 1, 2, and 3).
All the set zones are selected, and the zone selection indicator of the function key R1 lights green.

Note

To reset selection, press the function key R1 again or the function key R5 (zone clear).
The selection indicator goes off.

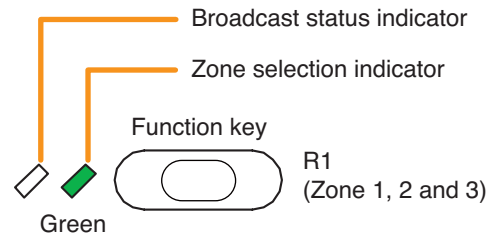

Step 2. Press the function key R7 (general EV broadcast).
General EV message is broadcast to the selected zones.
The Zone selection indicator of the function key R7 lights green, and the Broadcast status indicator lights yellow.
Also Broadcast status indicators of the function keys R1, R2, R3, and R4 flash green.

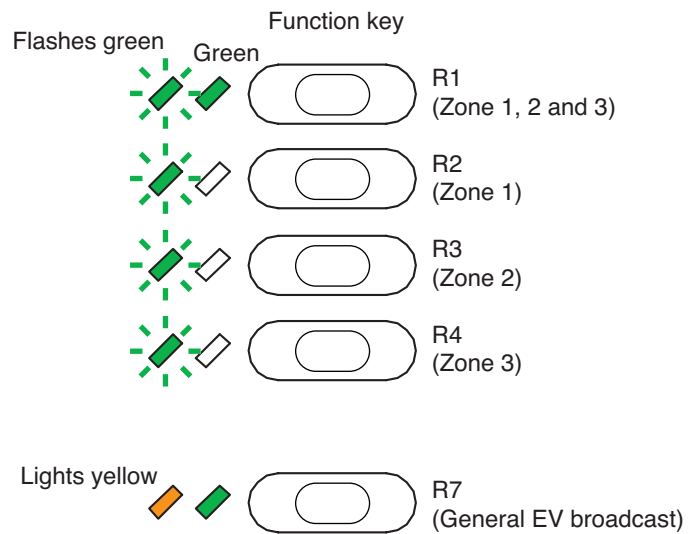

2. MAKING GENERAL URGENCY ALL-CALLS

If normal broadcasts cannot be made due to system failure or some trouble, only an all-call is possible in the following procedure.

This is a broadcast made by bypassing the CPU*1 that normally operates in the SX-2000 system. (For details, see the separate Installation Manual, "Installation" and "Connections.")

If the SX-2000 system receives a 24 V emergency cutoff signal*2, the general urgency all-call is disabled because the emergency broadcast system takes precedence over the SX-2000 system.

*1 CPU is a central processing unit, which is built in the SX-2000SM, SX-2000AI, SX-2100AI, SX-2000AO, and SX-2100AO.

*2 In the SX-2000 system, a 24 V emergency cutoff input terminal that allows control of an emergency audio input is provided on the SX-2000AO's rear panel. When the SX-2000 system is combined with another emergency broadcast system, a 24 V DC is normally kept being supplied to this emergency cutoff input terminal and is cut off (24 V emergency cutoff function) in emergency situations. This interrupts the general-purpose broadcast from the SX-2000, allowing the emergency broadcast system to override it. (For details, see the separate Installation Manual, "Installation.")

General urgency all-calls can be made following the procedure below independently of settings performed using the SX-2000 Setting Software.

2.1. Making General Urgency All-Calls from the RM-200SA

Open the cover of the General Urgency All-Call key, then while holding down the key, wait about 4 seconds until the Failure indicator lights red and begin to make microphone announcements.

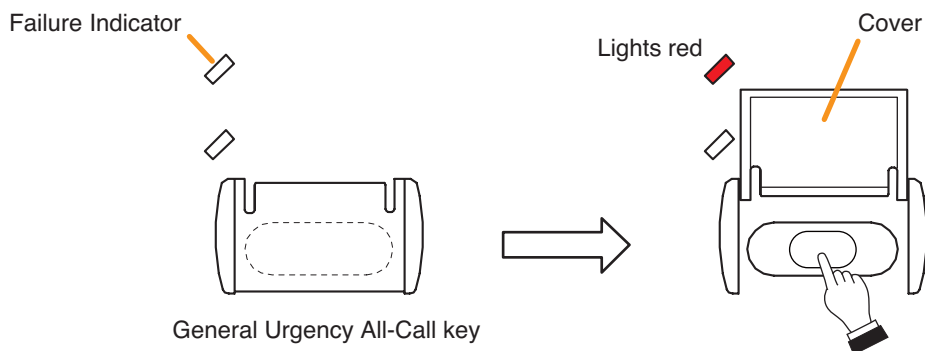

Note

The RM-200SA's DIP switch 5 (factory default: ON) must be preset to ON to enable the CPU OFF function (general urgency all-call).

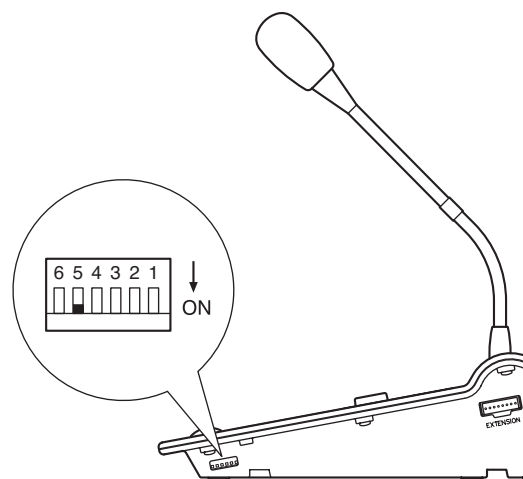

2.2. Making General Urgency All-Calls from the RM-200SF

Step 1. Set the CPU switch on the top surface to OFF.

Note: The CPU switch is factory-preset to ON.

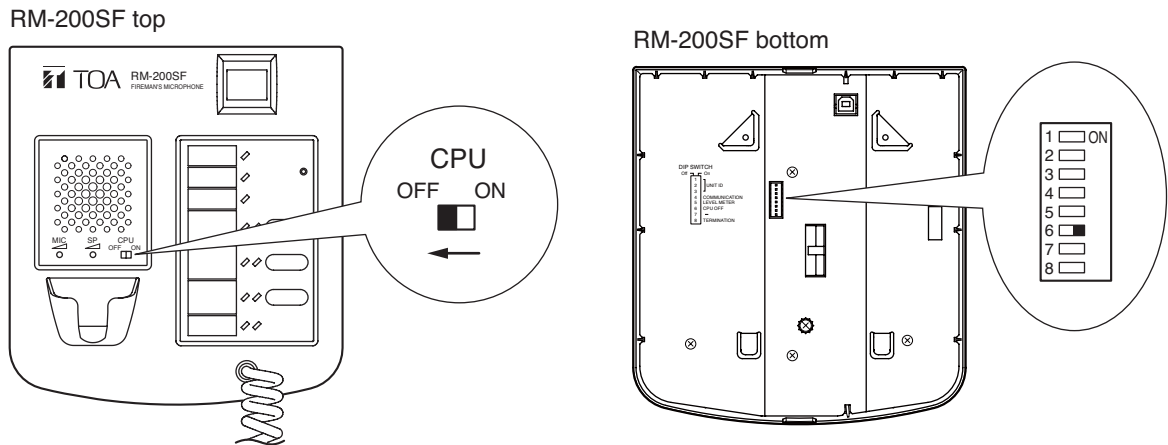

Note

The RM-200SF's DIP switch 6 (factory default: ON) must be preset to ON to enable the CPU OFF function (general urgency all-call).

Step 2. Make the microphone announcement while holding down the Talk key.

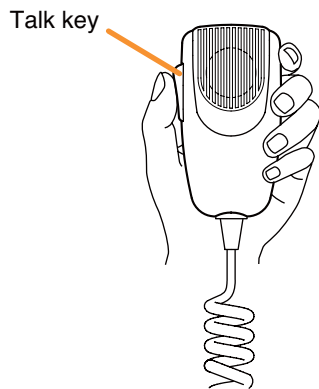

Step 3. When the microphone announcement is complete, return the CPU switch to ON.

3. EMERGENCY BROADCASTS

3.1. Typical System Examples

Here, an example of sequential operation with the SX-2000 is explained.

[Sequential Operation]

Sequential operation consists of Phase 1 and Phase 2.

Sequence Phase 1 operates upon emergency system activation. When the set time interval elapses, the broadcast is automatically switched to Phase 2.

[Setting Contents]

Both the broadcast messages and output zones are set for Phase 1 and Phase 2.

Assuming that these phases are set as follows:

Phase 1: The alert message is continuously broadcast for 5 minutes to each floor of each building.

Phase 2: The evacuation message is continuously broadcast to the entire zone.

[Alert and Evacuation Message Examples.]

Alert Message: The fire alarm system has been engaged. We are now checking the cause. Please wait for further information.

Evacuation Message: There is a fire. Please evacuate immediately.

Step 1. Background music (BGM) is broadcast to A-GF (Building A ground floor) and B-GF (Building B ground floor) when the system is in general-purpose broadcast mode.

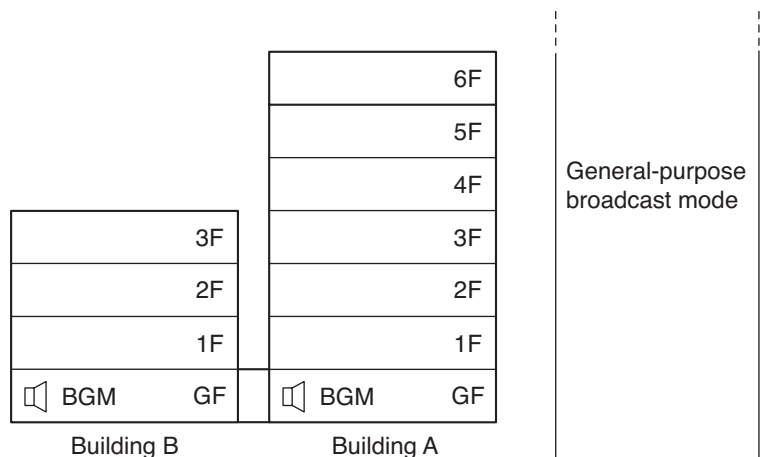

Step 2. The sensor installed on A-3F detects irregularities, and the fire alarm system transmits a control signal to the control input. The emergency mode is activated, allowing the alert message to be played through to A-3F.

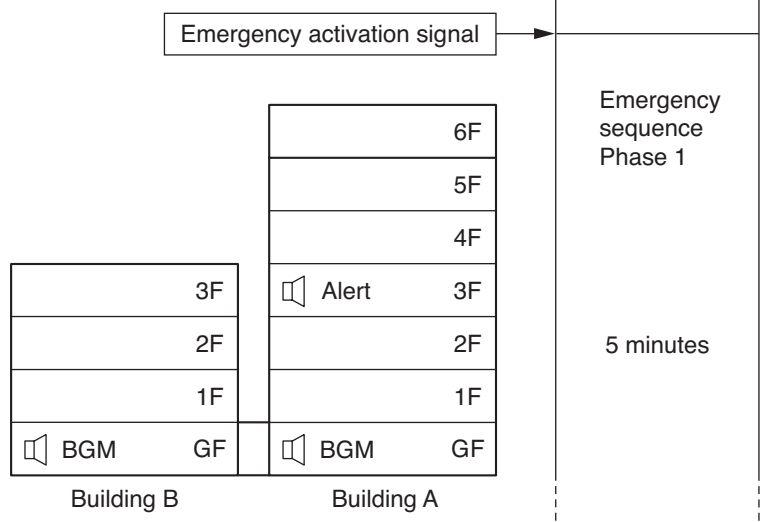

Step 3. Following this, the sensors installed on A-2F and A-4F detect irregularities and the fire alarm system transmits a control signal to the control input. Broadcast zones are added, and the alert message is also broadcast to A-2F and A-4F, as well.

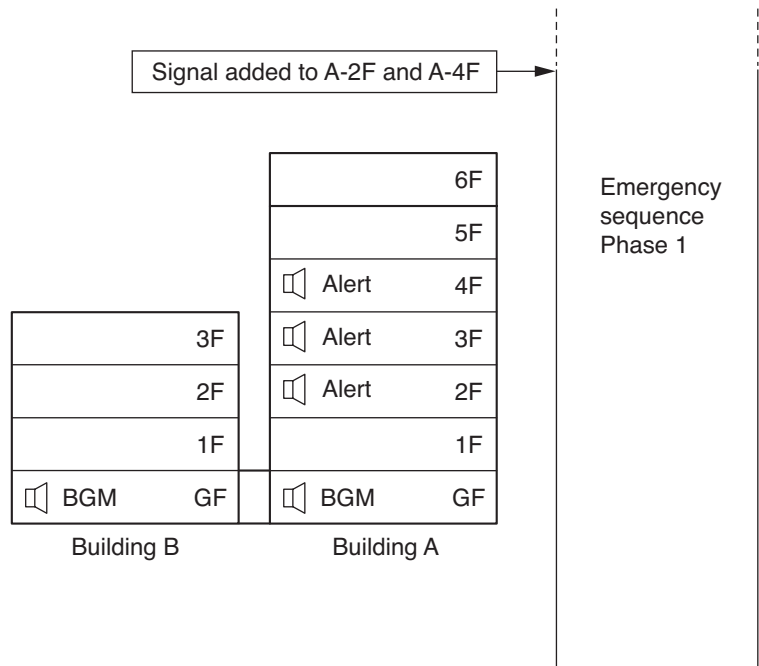

Step 4. After the set 5-minute time interval elapses, the message is automatically switched from Phase 1 to Phase 2. Broadcast zones change to the "entire zone" and the evacuation message is broadcast to the entire area, and BGM stops. The evacuation announcement continues until the Remote Microphone's Reset key is pressed or a restoration signal is transmitted from the connected fire alarm system.

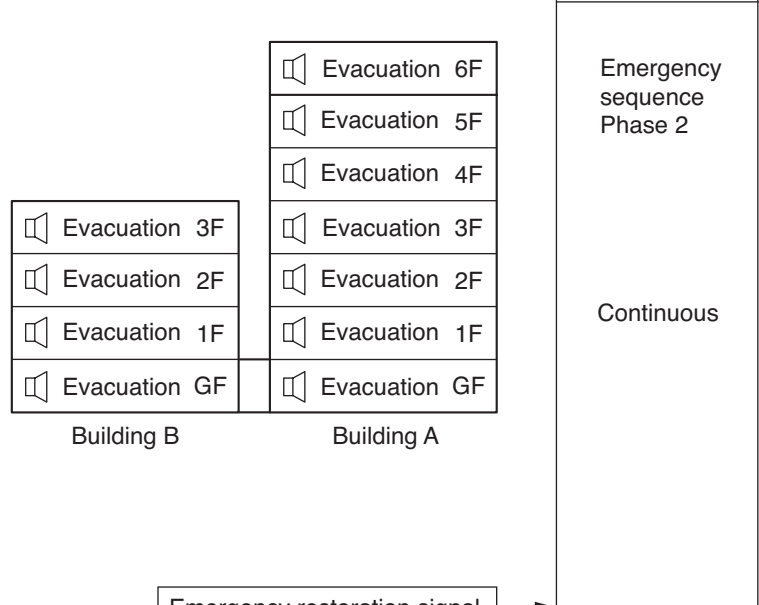

Step 5. The fire alarm system transmits a restoration control signal to the control input. The emergency mode is terminated and the broadcast reverts to general-purpose broadcast mode, restoring BGM output.

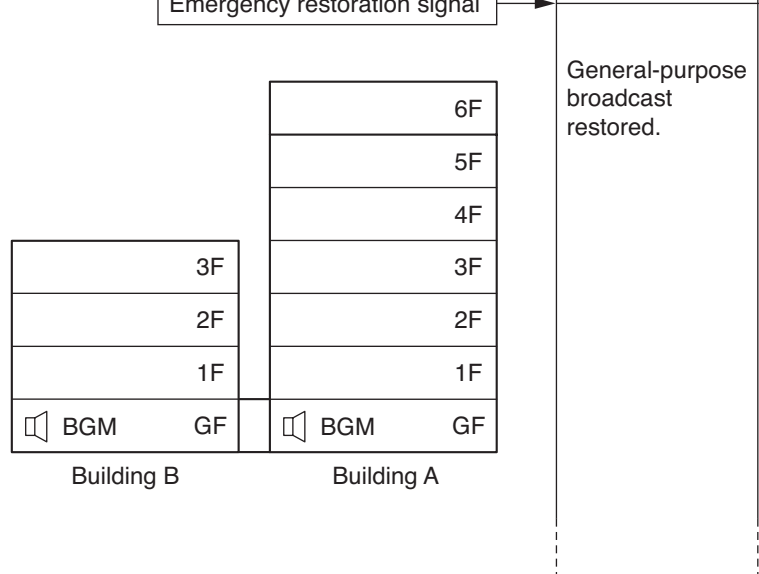

3.2. Remote Microphone Operation Example

The emergency mode can not only be activated and restored from the connected fire alarm system, but also from any Remote Microphone (RM-200SA or RM-200SF) set for emergency/general-purpose operation.

Here, the settings of the Fireman's Microphone RM-200SF installed on GF of Building A are used as an example to explain the flow from emergency mode activation to its restoration.

[Setting Contents of Fireman's Microphone]

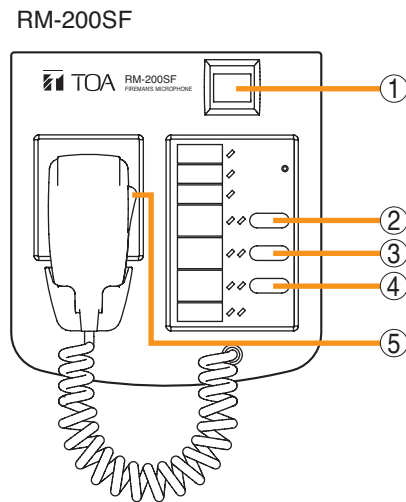

Key	Setting	Function
①	Emergency Broadcast Pattern Start	Activates emergency mode and recalls emergency sequence patterns. [Pattern contents] Phase 1: Alert message; all zones; 5 minutes Phase 2: Evacuation message; all zones; continuous
②	Emergency Sequence Phase Shift	Shifts the phase of the sequence pattern currently being broadcast to the next phase.
③	Emergency Reset (Reset message)	Broadcast is restored from emergency to normal (general-purpose) broadcast mode after Restoration message announcement completion.
④	All-Zone Call	Selects all zones.
⑤	Press-to-Talk	Makes microphone announcements.

For instructions on assigning functions to function keys, see the separate Setting Software Instructions, "Event Settings."

[Operation example]

Described below are the steps of system operation from emergency mode activation to restoration.

Step 1. Press the Emergency key (1).

- Emergency mode is activated and the Emergency key lights red.
- The pre-configured emergency sequence pattern is recalled, and the Alert Message is broadcast to all zones.
- The Zone monitor indicator of the All-Zone Call key (4) indicates the type of message currently being broadcast. It flashes red to indicate that an alert message is currently being broadcast.

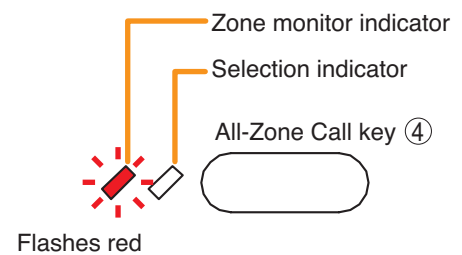
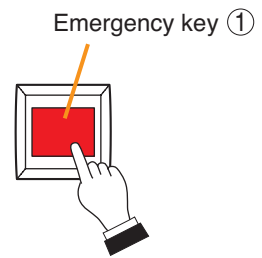

- The Phase state indicator of the Emergency Sequence Phase Shift key (2) lights green when the emergency sequence phase 1 is broadcast.

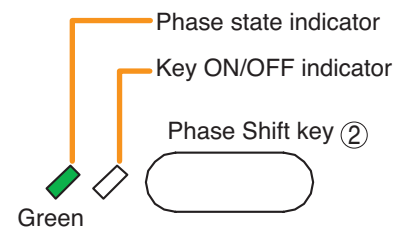

Step 2. Press the Emergency Phase Shift key (2) to broadcast the Evacuation message, if necessary. The Evacuation message will be broadcast to all zones. In this event, the broadcast pattern shifts from the emergency sequence phase 1 to the phase 2, and the Phase state indicator flashes green.

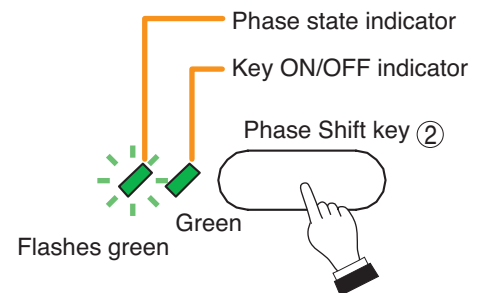

The Zone monitor indicator of the All-Zone Call key (4) indicates the type of message currently being broadcast. It changes from flashing red to steady red status to indicate that the evacuation message is being broadcast.

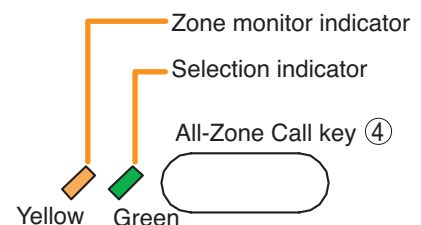

The Emergency Sequence function automatically switches the current message to the Evacuation message after a 5-minute interval if nothing is done.

Step 3. When making broadcast using the RM-200SF, follow the procedures below.

- Press the All-Zone Call key (4) to select all zones. In this event, the Selection indicator lights.

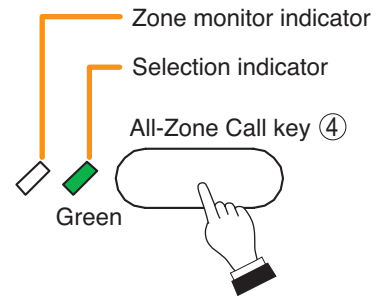

- Press the Talk switch (5), then make voice announcements to all zones. In this event, the Broadcast status indicator lights yellow, and the Microphone indicator lights green.

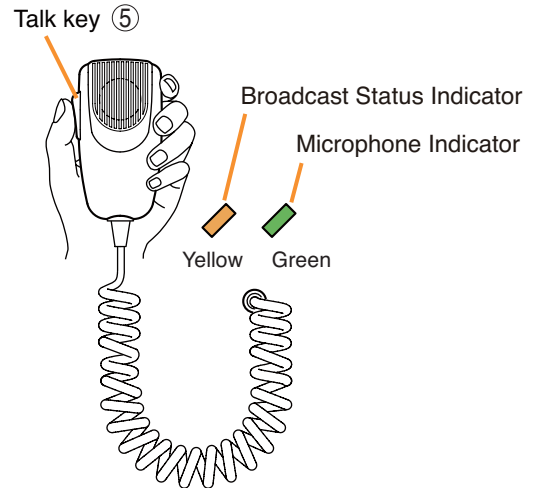

Also, the Zone monitor indicator of the All-Zone Call key (4) lights yellow.

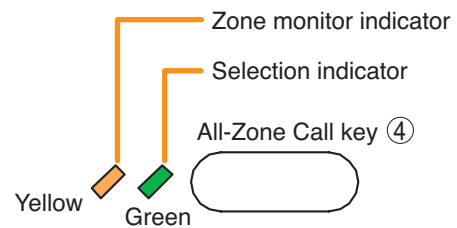

Tip

When a Fireman's Microphone announcement interrupts a message broadcast, the broadcast mode that follows Fireman's Microphone announcement completion can be set to either "Continue" for continuous EV message broadcast or "Silent" for broadcast termination. This setting can be made by using the SX-2000 Setting Software.

Step 4. Terminate the Emergency status.

Press the Emergency Reset key (3). The reset message is broadcast to the entire zone, and the Reset indicator of the Emergency Reset key (3) lights while the message is broadcast. After the message broadcast completion, the SX-2000 system is restored from Emergency status to the General-purpose broadcast status, and the Emergency status indicator (1) built in the Emergency key goes off.

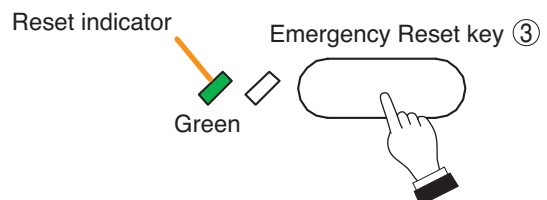
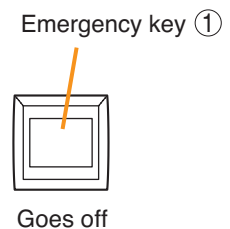

4. MAKING LOCAL BROADCASTS (SX-2100AO only)

Described below are system operation procedures when making local broadcasts via the SX-2100AO.

[Setting example]

Local input 1	Zone 1, Zone 2
Local input 2	Zone 1, Zone 2, Zone 3, Zone 4, Zone 5, Zone 6, Zone 7

Notes

- For the setting procedures, refer to the separate Setting Software Instructions, "AO Event Settings."
- For the pin arrangement diagram, refer to the separate Installation Manual, "Input Equipment Connections."

Step 1. Close the Local input 2's control input.
Local input 2 is output to the set zones (Zones 1 – 7).

Local input 2	Zone 7
Local input 2	Zone 6
Local input 2	Zone 5
Local input 2	Zone 4
Local input 2	Zone 3
Local input 2	Zone 2
Local input 2	Zone 1

Step 2. Close the Local input 1's control input.
Local input 1 is output to the set zones (Zones 1 and 2).

Tip

Local input 1 has a higher priority than Local input 2.

Local input 2	Zone 7
Local input 2	Zone 6
Local input 2	Zone 5
Local input 2	Zone 4
Local input 2	Zone 3
Local input 1	Zone 2
Local input 1	Zone 1

Step 3. Make general broadcasts to the Zone 2.

Tip

The Local input has a lower priority than the BGM or general-purpose sound sources.

Local input 2	Zone 7
Local input 2	Zone 6
Local input 2	Zone 5
Local input 2	Zone 4
Local input 2	Zone 3
General-purpose broadcast	Zone 2
Local input 1	Zone 1

Step 4. Make emergency broadcasts to the Zone 1.
Activating the emergency broadcasts to a part of zones where local broadcasts are currently in progress causes all local broadcasts to terminate.

	Zone 7
	Zone 6
	Zone 5
	Zone 4
	Zone 3
General-purpose broadcast	Zone 2
Alert	Zone 1

5. ADJUSTING INPUT/OUTPUT VOLUME

It is possible to adjust the volume for each input channel via the front panel of the SX-2000AI or SX-2100AI. It is also possible to adjust the volume for each output channel via the front panel of the SX-2000AO or SX-2100AO.

The adjustment method is the same for both.

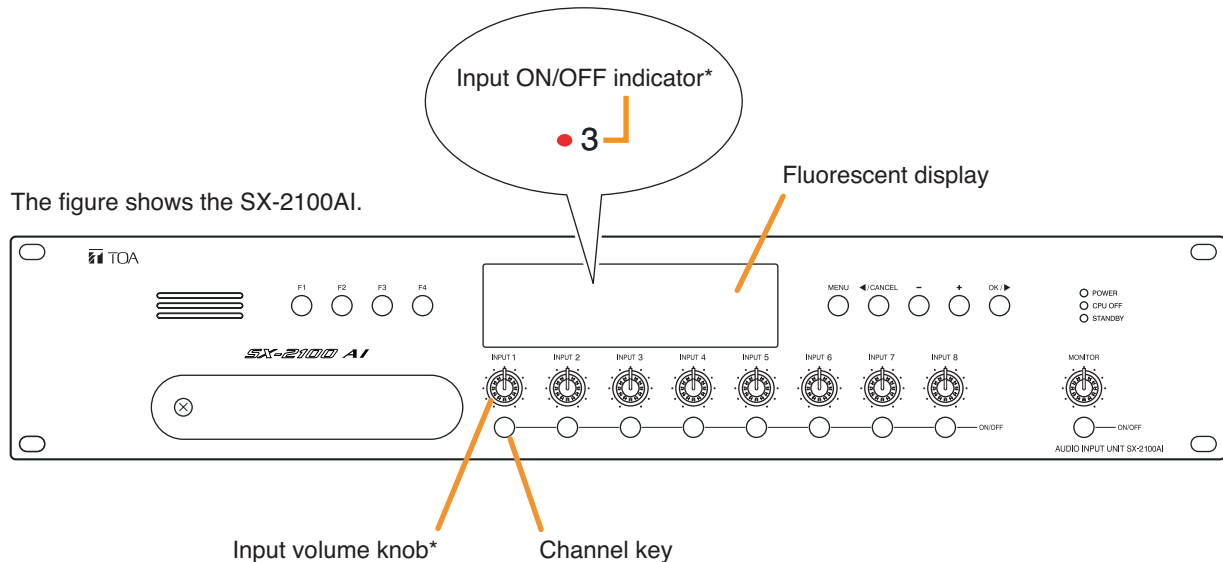

* These volume knobs and indicators are the output volume knobs and output ON/OFF indicators in the case of SX-2000AO and SX-2100AO.

[When the channel key is set for the input (output) ON/OFF function (default setting)]

Set the channel key for the desired input (output) channel to ON, then use the volume knob above it to adjust the volume.

When the channel key is set to ON, the input (output) ON/OFF indicator on the fluorescent display lights. However, if the input (output) volume knob has been set to the minimum volume position by rotating it fully counterclockwise, the channel remains OFF and the input (output) ON/OFF indicator also remains unlit.

The setting value for the input (output) volume knob can be confirmed using menu screen (AI8, ai8, AO8, ao8). (See p. 2-12, 3-12, 4-12, 5-12.)

[When the channel key is set for other function except input (output) ON/OFF function]

The channel corresponding to that channel key is always ON. Therefore, the volume on the channel can be adjusted only by turning the corresponding volume knob.

The setting value for the input (output) volume knob can be confirmed using menu screen (AI8, ai8, AO8, ao8). (See p. 2-12, 3-12, 4-12, 5-12.)

6. MONITORING INPUT/OUTPUT CHANNELS

The SX-2000AI, SX-2100AI, SX-2000AO, and SX-2100AO are equipped with monitor speakers on their front panels, which allow monitoring of each input (SX-2000AI or SX-2100AI) or output (SX-2000AO or SX-2100AO) channel.

The monitoring method is the same for both.

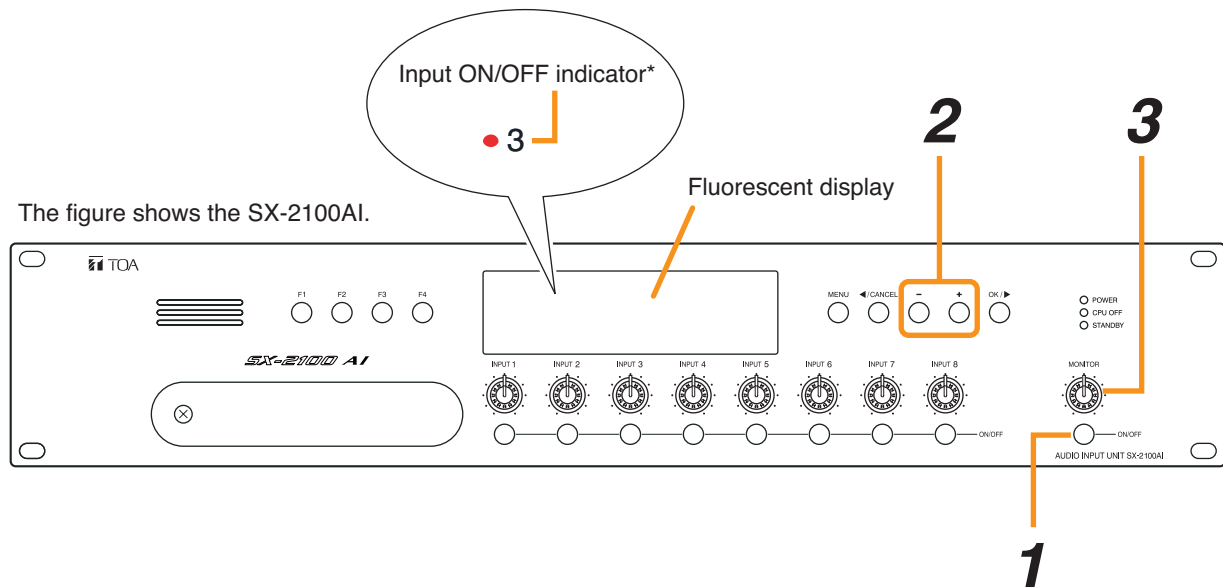

Note

The indications on the fluorescent display described below are those when the unit displays the default screen.

Step 1. Set the Monitor ON/OFF key to ON.

The monitor ON/OFF indicator and monitor level meter scale on the fluorescent display will light.

Step 2. Use the plus or minus key to select the desired input (output) channel to be monitored.

Pressing the plus key increases the channel number, while pressing the minus key decreases the channel number. The input (output) indicator for the selected channel will light red on the fluorescent display.

Step 3. Use the monitor volume control to adjust the volume.

7. DETECTING FAULT

If a malfunction occurs within the SX-2000 system, the fault state can be indicated, acknowledged or reset using the following keys or control terminals.

- FAULT ACK and FAULT RESET keys on the SX-2000SM
- Data input terminals (ACK terminals and RES terminals) on the SX-2000SM
- Control input terminals of the SX-2000SM, SX-2100AI, SX-2000AO, SX-2100AO, and SX-2000CI
- Function keys on the RM-200SA or RM-200SF.

Note

Regarding the setting procedures for detecting fault within the SX-2000 system, refer to the separate software instruction manual. (See the separate Setting Software Instructions, "Basic Settings.")

7.1. Fault Detection Setting Example

The method to detect the fault within the system using the SX-2000SM, RM-200SF, and RM-210 is described below.

[System configuration]

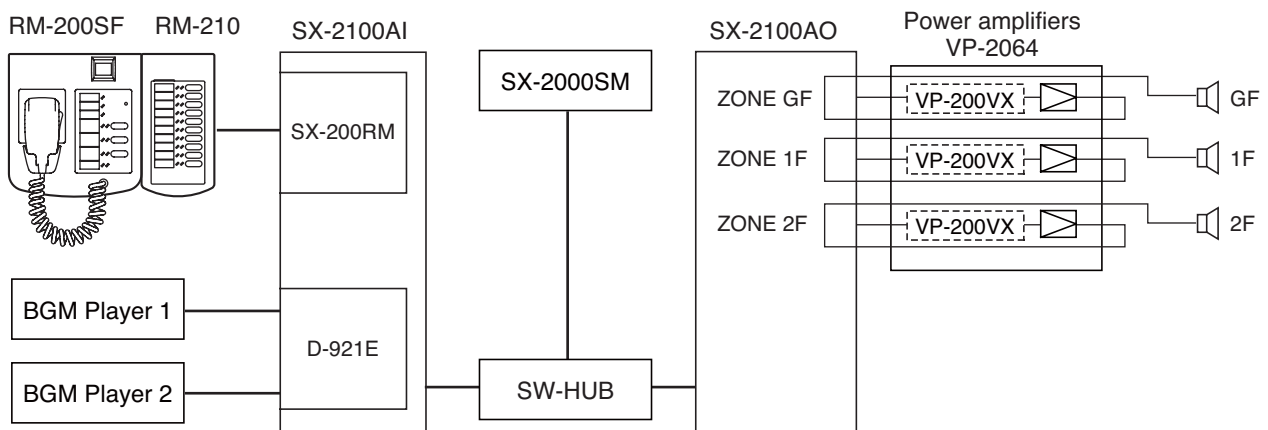

[Remote Microphone's Function key setting]

RM-200SF

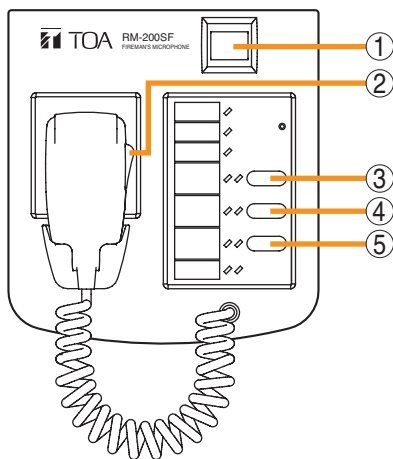

Key	Set function
①	(Not set)
②	Talk key (fixed)
③	Zone Clear
④	Failure Output Reset
⑤	Lamp Test

RM-210

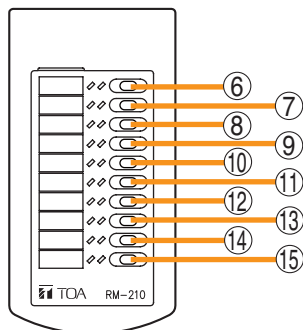

Key	Set function	Contents (failure pattern)
⑥	Failure Output Receipt	SX-2000SM
⑦	Failure Output Receipt	SX-2100AI
⑧	Failure Output Receipt	SX-2100AO
⑨	Failure Output Receipt	RM-200SF
⑩	Failure Output Receipt	AO Amplifier ZONE GF
⑪	Failure Output Receipt	AO Amplifier ZONE 1F
⑫	Failure Output Receipt	AO Amplifier ZONE 2F
⑬	Failure Output Receipt	AO Speaker ZONE GF
⑭	Failure Output Receipt	AO Speaker ZONE 1F
⑮	Failure Output Receipt	AO Speaker ZONE 2F

Notes

- For instructions on assigning functions to function keys, see the separate Setting Software Instructions, "Event Settings."
- For instructions on setting failure pattern, see the separate Setting Software Instructions, "Pattern Settings."

7.2. Case Example of Malfunction

The example here assumes that the speaker terminal for the Zone 2F is disconnected.

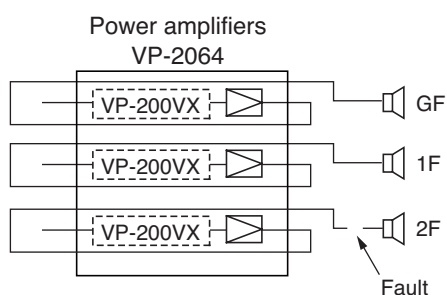

7.3. Remote Microphone's Operation Example

When the failure is detected, the buzzer built in the remote microphone sounds, and the Zone 2F failure output receipt state indicator flashes yellow.

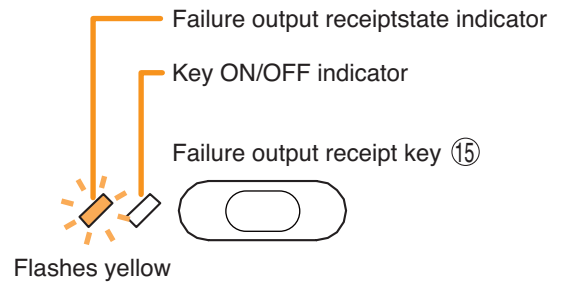

Step 1. Press the Failure output receipt key (15) to acknowledge the failure.

The buzzer stops sounding, and the Failure output receipt state indicator switches from flashing to steady on.

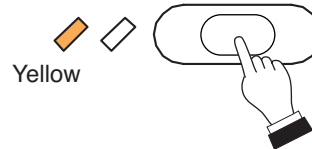

Step 2. Locate the cause, then remove it.

Remove the CF card inserted into the SX-2000SM, connect it to a PC and read the log data using the SX-2000 Setting Software. (For information about storing log data on a CF card, see [p. 1-5, "Outputting Log Data."](#))

Tip: Log data are confirmed online by establishing communications between the SX-2000SM and a PC. For details, refer to the separate Setting Software Instructions, "Utility."

Confirm the cause of failure or abnormality on the log data (in this example, the log data that the speaker terminal for the zone 2F is open state is listed), then fix the fault part.

Note

For most failure indications, the failure LED automatically goes off when the cause has been corrected. For certain other failure indications, such as power amplifier failure or speaker shorts, the LED does not automatically go off. In such cases, Failure Output Reset key needs to be pressed.

Step 3. Press the Failure Output Reset key (4).

The Failure output receipt state indicator goes off.

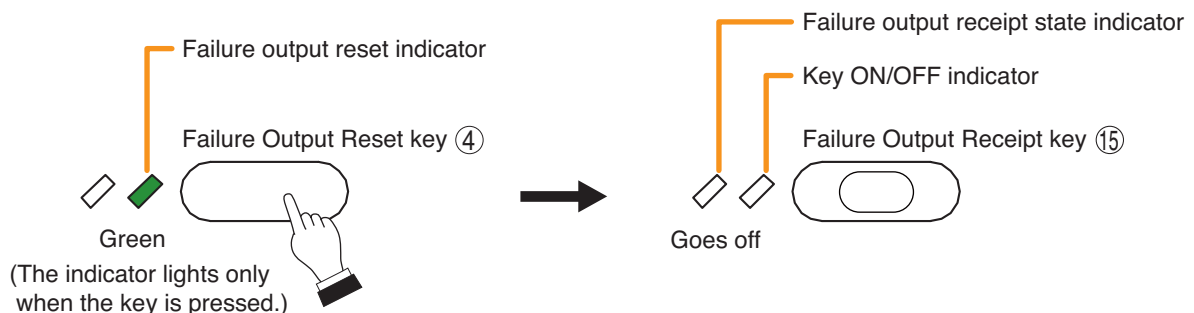

7.4. SX-2000SM's Operation Example

When the failure is detected, the built-in buzzer sounds, and the GENERAL indicator on the front panel flashes.

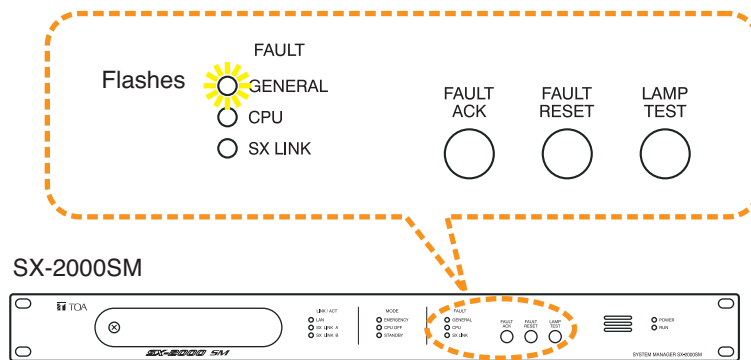

- Step 1.** Press the FAULT ACK key to acknowledge the failure.
The buzzer stops sounding, and the GENERAL indicator switches from flashing to steady on.

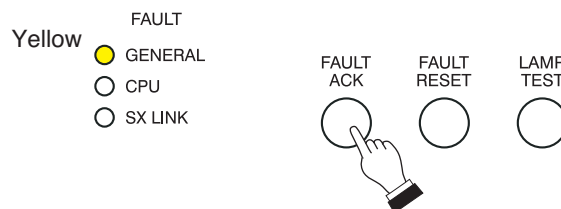

Notes

- When the failure reception function has been assigned to the control input terminal on the rear panel of the SX-2000SM, SX-2100AI, SX-2000AO, SX-2100AO, or SX-2000CI, it is also possible to receive a system failure via control input. For details, refer to the separate Setting Software Instructions, "Event Settings."
- It is also possible to receive a system failure by shorting the Data input terminals (ACK terminals) on the rear panel of the SX-2000SM.

- Step 2.** Locate the cause, then remove it.
Remove the CF card inserted into the SX-2000SM, connect it to a PC and read the log data using the SX-2000 Setting Software. (For information about storing log data on a CF card, see [p. 1-5, "Outputting Log Data."](#))

Tip: Log data are confirmed online by establishing communications between the SX-2000SM and a PC. For details, refer to the separate Setting Software Instructions, "Utility."

Confirm the cause of failure or abnormality on the log data (in this example, the log data that the speaker terminal for the zone 2F is open state is listed), then fix the fault part.

Note

For most failure indications, the failure LED automatically goes off when the cause has been corrected. For certain other failure indications, such as power amplifier failure or speaker shorts, the LED does not automatically go off. In such cases, FAULT RESET key needs to be pressed.

Step 3. Reset the failure information.
There are 3 failure reset methods described below

3-1. Resetting the failure information using the FAULT RESET key
The reset operation mode differs depending on the DIP switch 4 setting (p. 1-3).

• **One touch mode: When DIP switch 4 is set to "OFF" (default)**

Press the FAULT RESET key.
The GENERAL indicator goes off, and the SX-2000 system returns to normal state.

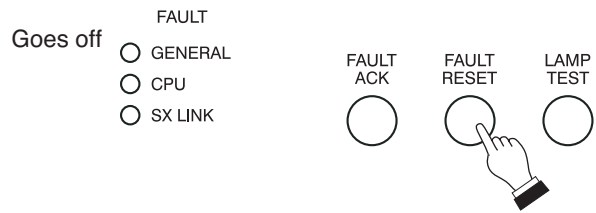

• **Accidental operation prevention mode: When DIP switch 4 is set to "ON"**

Press the FAULT RESET key 3 times. Hold down the key for 2 seconds or more for the third time.
(Refer to the figure below.)

When 2 seconds elapse after holding down the key for the third time, the GENERAL indicator goes off, and the SX-2000 system returns to normal state.

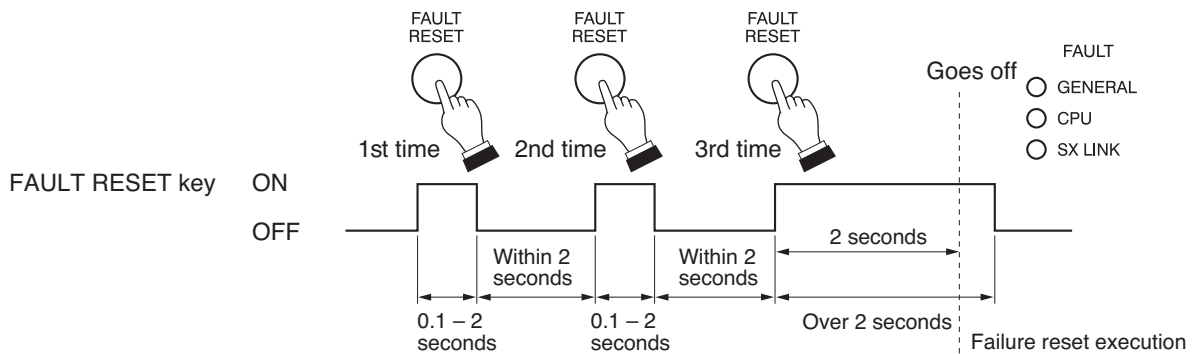

Note

When the FAULT RESET key remains unpressed for 2 seconds or more, the operation so far performed becomes invalid.

3-2. Resetting the failure information by way of the Data input terminals (RES terminals)

According to the DIP switch 4 setting (p. 1-3), short the Data input terminals (RES terminals) at the same timing as the FAULT RESET key is pressed.

• **When DIP switch 4 is set to "OFF" (default) (one touch mode)**

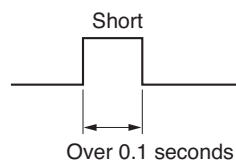

• **When DIP switch 4 is set to "ON" (accidental operation prevention mode:)**

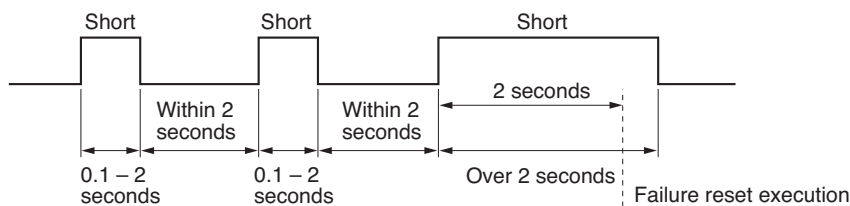

3-3. Resetting the failure information by way of the Control input terminals

Reset the failure information using the terminal the failure reset function has been assigned to.
(For the function assignment, refer to the separate software instruction manual, "Event Settings.")
Short the terminals with a one-shot pulse regardless of the DIP switch 4 setting.

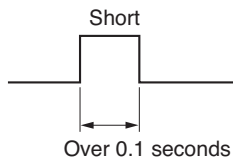
**7.5. Example of Executing the Failure Reception and Failure Reset by Way of the Control Input Terminals**

Assign the failure reception and failure reset functions to the control input terminals on the rear panel of the SX-2000SM, SX-2100AI, SX-2000AO, SX-2100AO, and SX-2000CI in advance.

(For details, refer to the separate software instruction manual, "Event Settings.")

Short each function-assigned terminals with a one-shot pulse.

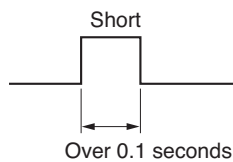
**Note**

The failure reset method by way of the control input terminals is not subject to the SX-2000SM's DIP switch 4 setting.

8. LAMP TEST

Executing the lamp test at each of the SX-2000SM, RM-200SF, RM-200SA, and RM-210 causes its all indicators to light up and the built-in buzzer to sound, permitting the operation test for the indicators and speaker.

8.1. Remote Microphone's Operation Example

[Remote Microphone's Function key setting]

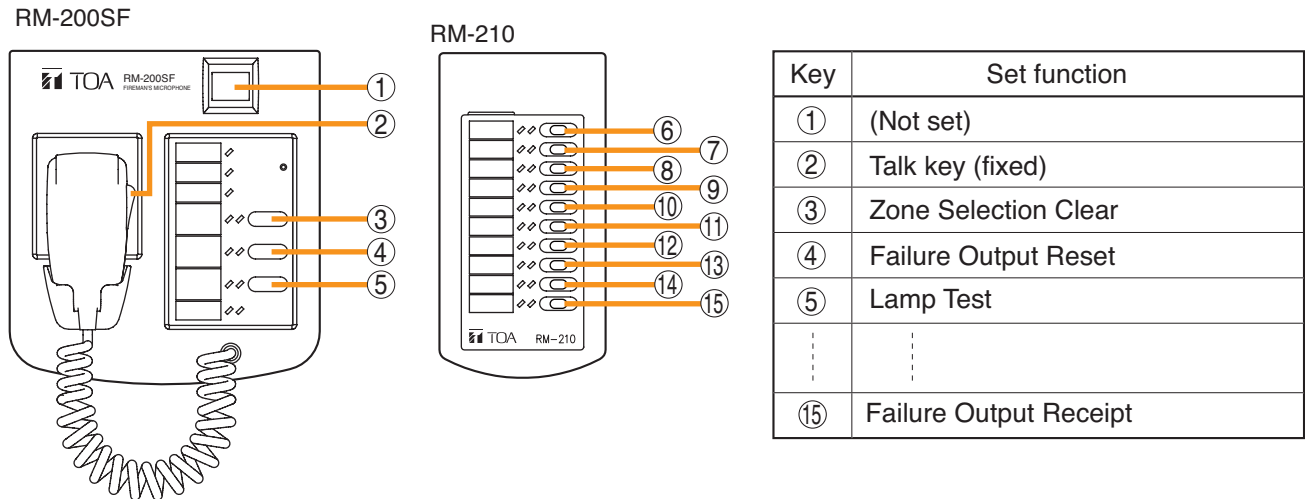

Note

For instructions on assigning functions to function keys, see the separate Setting Software Instructions, "Event Settings."

Step 1. Continuously press the Lamp Test key (5).

All the indicators except the CPU indicator light and the buzzer built in the RM-200SF sounds.

Step 2. Confirm that the indicators and speaker operate correctly as in Step 1.

Step 3. Release the Lamp Test key (5) to finish the lamp test.

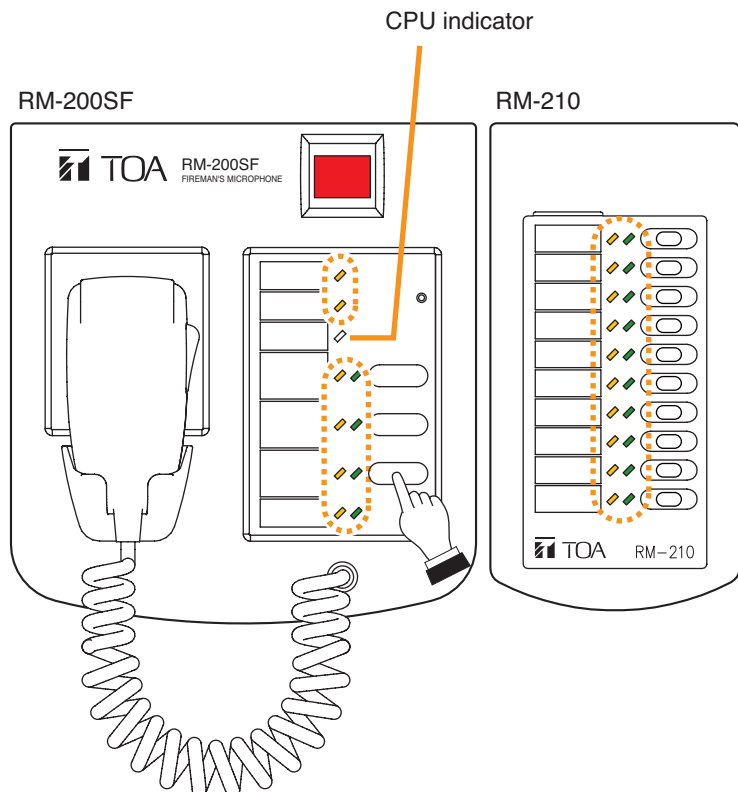

8.2. SX-2000SM's Operation Example

Step 1. Continuously press the LAMP TEST key.

All the indicators (EMERGENCY, CPU OFF, STANDBY, GENERAL, CPU, and SX LINK) light, and the buzzer built in the SX-2000SM sounds.

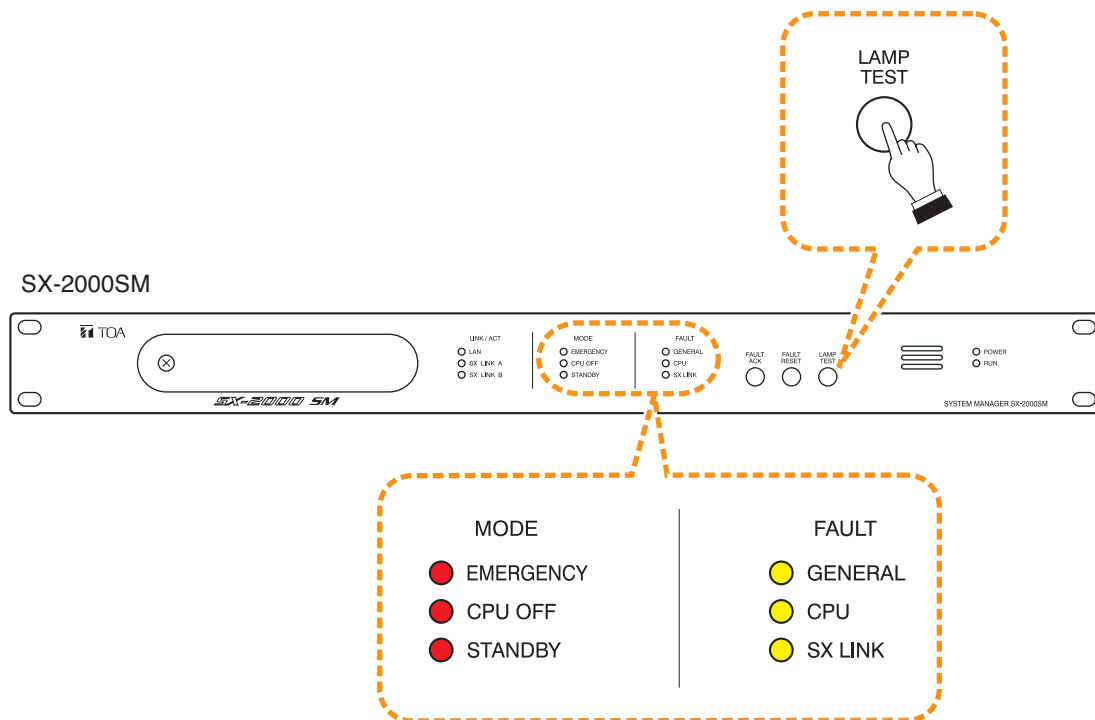

Step 2. Confirm that the indicators and buzzer operate correctly as in Step 1.

Step 3. Release the LAMP TEST key to finish the lamp test.

